

Montana Bureau of Mines and Geology
Open-File Report

Ground-Water Evaluation
Seeley Lake, Montana

by

Peter M. Norbeck

and

Catherine McDonald

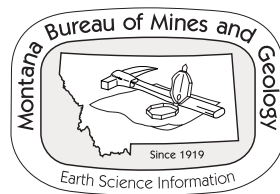

Table of Contents

Introduction	1
Acknowledgments	1
Location	1
Physiography and climate	4
Reasons for evaluation	4
Scope and methods	6
Surface water	8
Streams and lakes	8
Surface-water use	10
Hydrogeology	10
Recharge/discharge	14
Ground-water use	16
Ground-water availability	17
Water Quality	19
Surface-water quality	19
Ground-water quality	21
Ground water: influence of septic effluent	24
Conclusions and recommendations	34
References	37
Appendix A. Surface-water inventory data	
Appendix B. Surface-water quality data	
Appendix C. Ground-water inventory data	
Appendix D. Ground-water quality data	
Appendix E. Septic system information	

Tables

Table 1. Seeley Lake Ranger Station, climatic data	4
Table 2. Seepage rates	16
Table 3. Seeley Lake aquifer-test data	18
Table 4. Typical septic-tank effluent characteristics	24
Table 5. Seeley Lake nitrate-loading calculations	32

Figures

Figure 1. Project location map	2
Figure 2. New water wells and septic systems, Seeley Lake	3
Figure 3. Discharge, Clearwater River near Clearwater Junction, MT	9
Figure 4. Geologic map, Seeley Lake area	11
Figure 5. Seeley Lake cross-section	12
Figure 6. Ionic percentages in surface-water	20
Figure 7. Ionic percentages in ground water, MBMG samples	22
Figure 8. Ionic percentages in ground water, UofM samples	23
Figure 9. Nitrate in Seeley Lake area ground water	26
Figure 10. Probability plot, nitrate in Seeley Lake ground water	26
Figure 11. Chloride vs nitrate in Seeley Lake area ground water	26
Figure 12. Probability plot, chloride in Seeley Lake area ground water	26
Figure 13. Sodium vs calcium and magnesium in Seeley Lake water samples	29
Figure 14. Bicarbonate vs sulfate in Seeley Lake water samples	29
Figure 15. Ionic concentrations vs well depth	30
Figure 16. Chloride and nitrate concentrations vs sample date	33
Figure 16. Proposed monitoring well-locations	36

Plates

Plate 1. Ground-water levels and flow directions
Plate 2. Sample sites, Seeley Lake
Plate 3. Generalized water quality, Seeley Lake
Plate 4. Septic-system locations

Introduction

Acknowledgments

This study was funded under the Renewable Resource Grant and Loan Program administered by the Montana Department of Natural Resources and Conservation. The Seeley Lake Water District and the Seeley Lake Sewer District provided valuable support and assistance throughout the project.

Location

The community of Seeley Lake is on the southeast shore of Seeley Lake in Missoula County in western Montana (figure 1). The community, located about 50 road miles northwest of the county seat Missoula, has a population of approximately 1200 permanent and part-time residents.

Historically, the economic base for the community and surrounding area has been the wood products industry. A sawmill in Seeley Lake cuts logs harvested locally and elsewhere throughout the state. The area is undergoing a shift from its historical economy to an economy based on tourism and seasonal homes. The number of new homes constructed per decade in and around the community of Seeley Lake, as gauged by domestic water-well and septic-system installations, has increased substantially during the past few decades (figure 2).

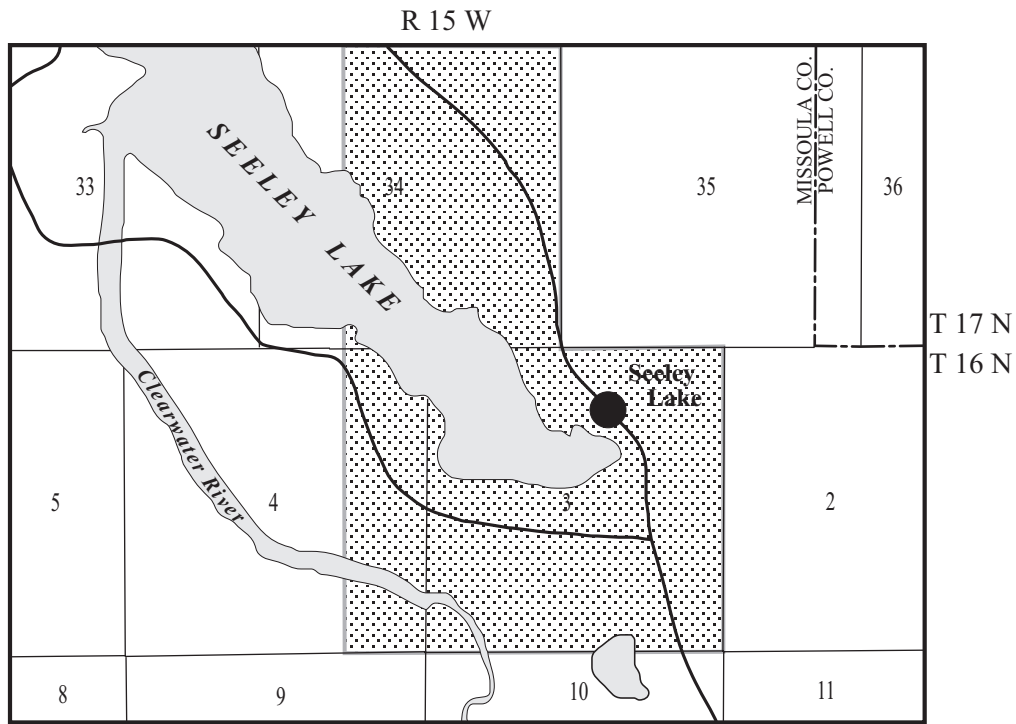

 Study area

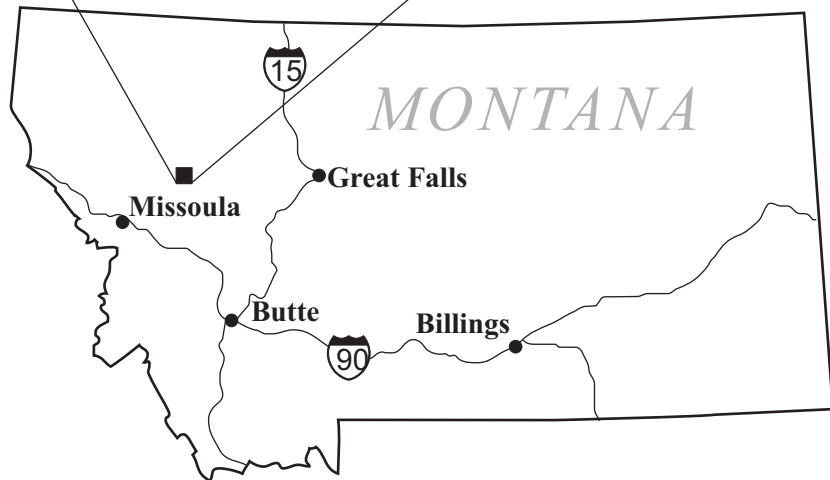
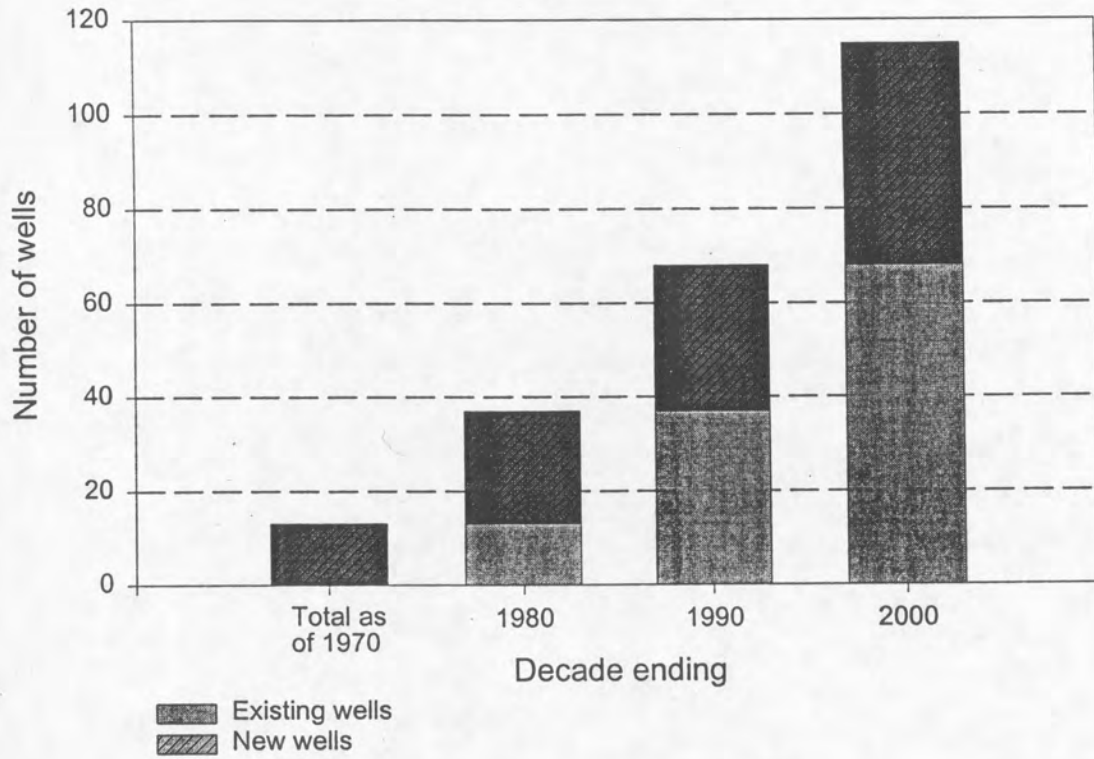

Figure 1. Project location map.

New water wells, Seeley Lake



New septic-system installations, Seeley Lake

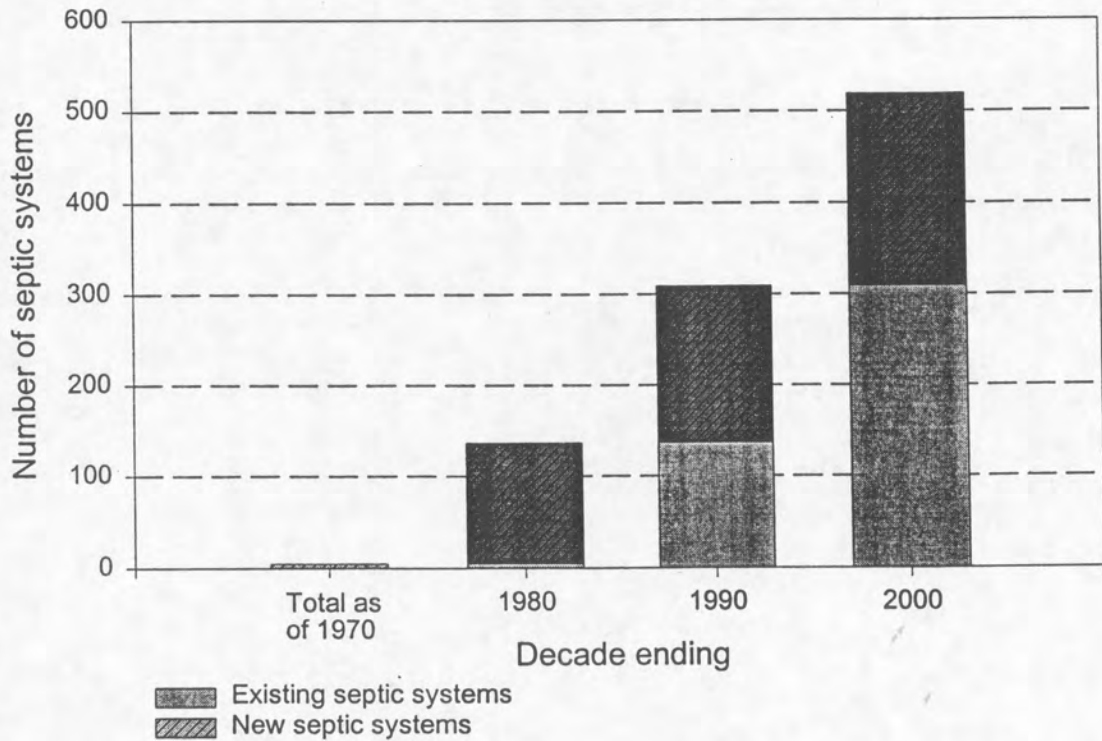

Figure 2. New water wells and septic systems, Seeley Lake.

Physiography and Climate

Seeley Lake is in the Clearwater River valley between the Swan Range to the east and the Mission Mountains to the west. Precipitation averages between 18 and 22 inches per year at the townsite, and comes mostly as snow. The mountains to the east and west receive as much as 50 to 80 inches of precipitation (Western Regional Climate Center, 1998). Climatic data for the Seeley Lake Ranger Station, located about 3 miles north of town are summarized in table 1.

Table 1: Seeley Lake Ranger Station, Climatic Data													
Elevation - 1250 m (4100') above sea level													
Latitude - 47 deg 13' N; Longitude – 113 deg 31' W													
County - Missoula													
Average Rainfall, 1922-1995													
	Jan	Feb	Mar	Apr	May	Jun	Jul	Aug	Sep	Oct	Nov	Dec	Year
mm	58.9	43.7	37.4	32.2	53.2	58.4	27.7	25.2	31.5	33.2	54.9	63.7	521.1
inch	2.3	1.7	1.5	1.3	2.1	2.3	1.1	1.0	1.2	1.3	2.2	2.5	20.5
Average Temperature, 1922-1995													
	Jan	Feb	Mar	Apr	May	Jun	Jul	Aug	Sep	Oct	Nov	Dec	Year
deg C	-6.6	-3.3	-0.1	4.6	9.3	13.7	16.7	16	11	6.4	-0.5	-5.8	5.1
deg F	20	26	32	40.3	48.7	56.7	62.1	62	53	43.5	31.1	22	41.2
Source: www.worldclimate.com													

Reasons for Evaluation

Because of rapid development in the Seeley Lake area and the proliferation of individual wells and septic tanks (figure 2), concerns have been raised over potential depletion of the ground-water supply and degradation of water quality. The community of Seeley Lake has a public water-supply system, but no central wastewater collection/treatment system. The water supply is drawn from the lake, which is fed by both ground water and surface water. The public water-supply intake is north of the townsite, and the system serves about 1200

residents, primarily in the northeast quarter and the east half of the southeast quarter of sec. 3 and part of the southwest quarter of sec. 2, T16, R15W (figure 1). Many lakeshore residents also derive their domestic water supply from the lake. Few wells are to be found in the town of Seeley Lake. Two wells are used for domestic supplies, one is used for lawn watering, two were installed for monitoring purposes during a University of Montana study and the rest are unused. Long-time residents point to algae and moss in the lake along the shore as evidence that water quality is becoming degraded over time. Rapid growth in the area, especially subdivisions bordering the townsite, are thought to be threats to ground water draining toward Seeley Lake and, therefore, ultimately to surface water.

Sediments underlying the project area are potential conduits for contaminants to ground or surface water. Undesirable impacts to area ground water and surface water from continued development include increased dissolved constituents (including nitrates and chlorides) and increased nutrient levels accompanied by algal growth in surface water. In addition to affecting a drinking water source, degradation of surface water could have a negative aesthetic effect on the lake and river which, in turn, could impact tourism, enjoyment of the lake by residents, and downstream uses. This study focuses on general hydrologic conditions in and around the town of Seeley Lake with the goal of determining where water has been affected by development. Nitrates are considered a prime indicator of human activity and were found to be an effective diagnostic tool at Seeley Lake.

Scope and Methods

Existing data from the Ground-Water Information Center (GWIC) and data collected during the 1996 and 1997 field seasons were used in this study. Existing reports on the geology and hydrology of the Seeley Lake area were reviewed for information pertinent to this study. Published data on ground-water levels, ground-water quality, surface-water flows, surface-water quality, aquifer properties, precipitation, and temperature were assembled. Geologic and topographic maps were obtained. Of special note is a ground-water study by the University of Montana under the direction of Dr. William Woessner (1996) and geologic mapping by Witkind & Weber (1982), Mudge (1982), and Noble and others (1982).

Well logs for the study area were obtained from GWIC files for use in the field during the inventory. U.S. Geological Survey 7.5 minute topographic maps and plat maps from Missoula County were used to ensure accurate locations of sites during the inventory. Ground-water information (location, source, water levels, water quality, etc.) in the GWIC database was incorporated into this report. Field data were used to augment, and in some cases, correct GWIC data.

Wells, springs, and septic tanks and related facilities in the study area (figure 1) were inventoried. Sites were visited, locations were marked on field maps, and pertinent data including a site sketch were recorded on inventory forms. The site sketch included locations of wells, septic tanks, drain fields, buildings, etc. Static water levels were measured in wells using steel tapes or electronic sounders. Sounding equipment was decontaminated using

distilled water, soap, and chlorine to prevent the spread of iron-using bacteria or other contaminants. Pumping rates were measured using a bucket and stop watch, and water levels were measured periodically during pumping. The following field parameters were also measured: air temperature, water temperature, pH, and specific conductance. Instruments for the measurement of pH and specific conductance were calibrated daily according to the manufacturer's recommendations.

Water usage was estimated from published data (Fetter, 1980). If no information on a well could be found in the GWIC data base, the well owner was asked for information on the total depth, lithology, casing, perforations, drilling date and other information normally found on well logs or appropriation forms. Estimated water-level elevations from the inventory and surveyed elevations from a University of Montana study (Woessner, 1996) were incorporated into a final water-level elevation map showing ground-water flow direction.

Septic-tank sizes and drainfield areas were recorded on field forms. Field forms included site location, owner, the number of people in the household(s) served by the septic system, percolation test information (if available), and a site sketch showing the location of the septic tank and drain field relative to property boundaries, buildings, and other pertinent features.

At the end of the first field season, the available data were reviewed and wells were selected for sampling: these included all wells in town, several wells up-gradient (northeast) from

town and a few wells south of town.

To ensure that the water being sampled was representative of the aquifer, wells were pumped until the field parameters stabilized or after removal of three well-bore volumes. Field parameters were considered stable when consecutive readings at 5-minute intervals did not vary by more than 10%.

Whenever possible during inventorying or sampling, the discharge rates and water levels were measured and used to calculate aquifer properties. These short-term tests usually were not of sufficient duration to permit identification of permeability boundaries, but they did provide estimates of aquifer properties in the immediate vicinities of the well bores. A water-level elevation map was prepared from water levels measured during this inventory and the inventory by Woessner (1996); water level elevations were used to determine ground-water flow directions and recharge/discharge relationships.

Surface Water

Streams and Lakes

Surface water near the town of Seeley Lake includes Seeley Creek, Morrell Creek, Trail Creek, Seeley Lake, and the Clearwater River (plate 1). Seeley Creek is a small perennial stream which enters Seeley Lake directly north of town from the east. Morrell Creek is a perennial stream which flows southward just east of town toward its confluence with the

Clearwater River about 2 miles south of town. Trail Creek is a perennial tributary to Morrell Creek. The perennial nature of these tributaries to the Clearwater River indicates that they are maintained by ground water during part of the year. The Clearwater River enters Seeley Lake at its extreme north end and exits at approximately the middle of the southwestern shore. The U.S. Geologic Survey maintained a gaging station on the Clearwater River near Clearwater Junction (approximately 15 miles south of Seeley Lake) from 1974 to 1992. A hydrograph for that station is shown in figure 3 (USGS, 1998). Flows peak at more than 1000 cubic feet per second (cfs) every spring during runoff in the months of April, May or June. During other months flows are mostly between 50 and 200 cfs and are maintained in large part by ground-water discharge.

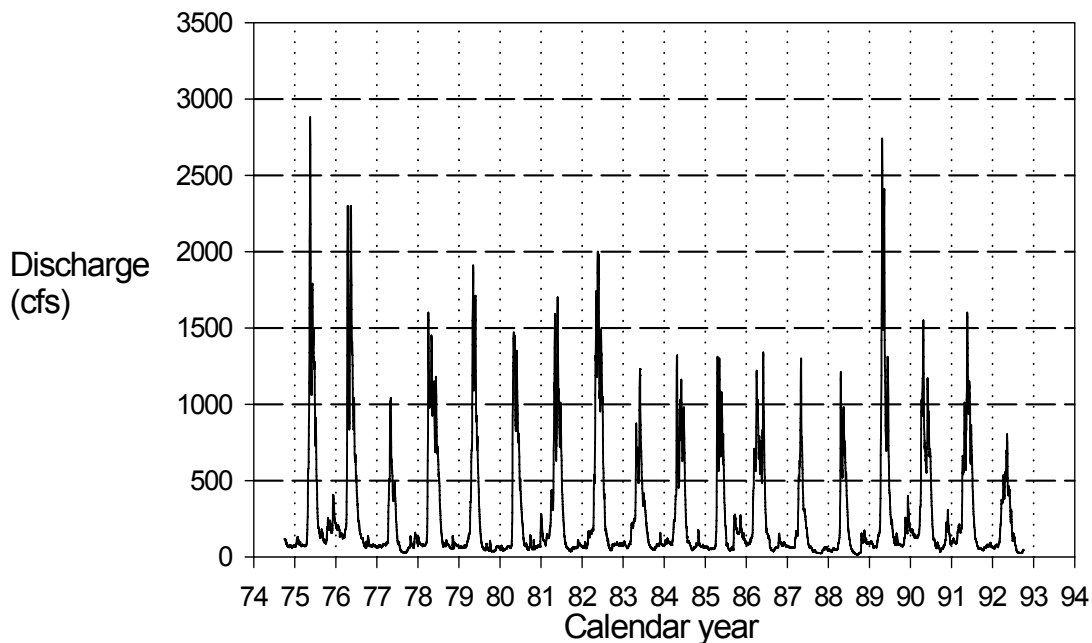

Figure 3: Discharge: Clearwater River near Clearwater Junction, MT.

Surface-Water Use

Surface water in and near Seeley Lake is used for domestic and municipal water supplies and for recreation. The estimated population in and near Seeley Lake served by surface water sources is 1200 (Torok, 1998). Fetter (1980) estimated per capita water usage at between 53 and 79 gallons per day for typical American households. The lower figure as an annual daily average is probably most appropriate for Seeley Lake owing to the number of seasonal residents. Based on these figures the estimated domestic consumption of surface water in the Seeley Lake area is 64,000 gallons per day or 70 acre-feet per year. This estimated domestic consumption is about 0.035% of the average annual discharge of 203,000 acre-feet per year for the Clearwater River at Clearwater Junction.

Hydrogeology

The geology of the Seeley Lake study area (figures 4 and 5) is characterized by gently dipping metasedimentary bedrock overlain by unconsolidated glacial and alluvial deposits. Bedrock outcrops exposed in the Mission Range on the west and the Swan Range on the east consist of argillite, sandstone, and dolomite of the Proterozoic Belt Supergroup. The valley fill consists of unconsolidated Quaternary glacial and alluvial deposits up to 600 feet thick (unpublished MBMG data). The geology of the area has been described by several investigators including Witkind (1977), Witkind & Weber (1982), Mudge (1982), and Noble and others (1982). The work of Witkind & Weber provides the most comprehensive description of the geology in the study area and is the basis for following summary:

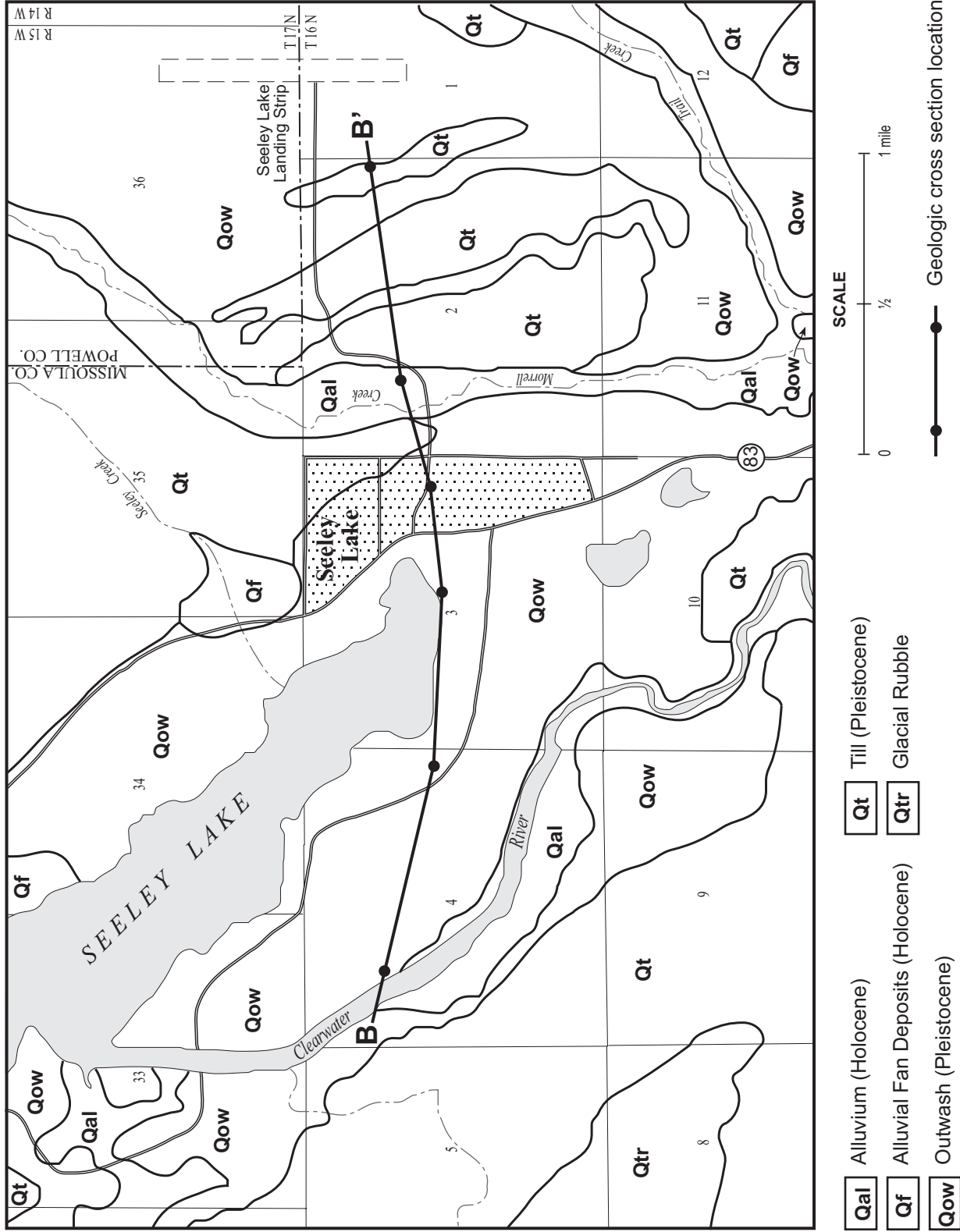

Figure 4. Generalized geologic map of surficial Quaternary (Q) deposits in the Seeley Lake area (Modified from Witkind & Weber, 1982)

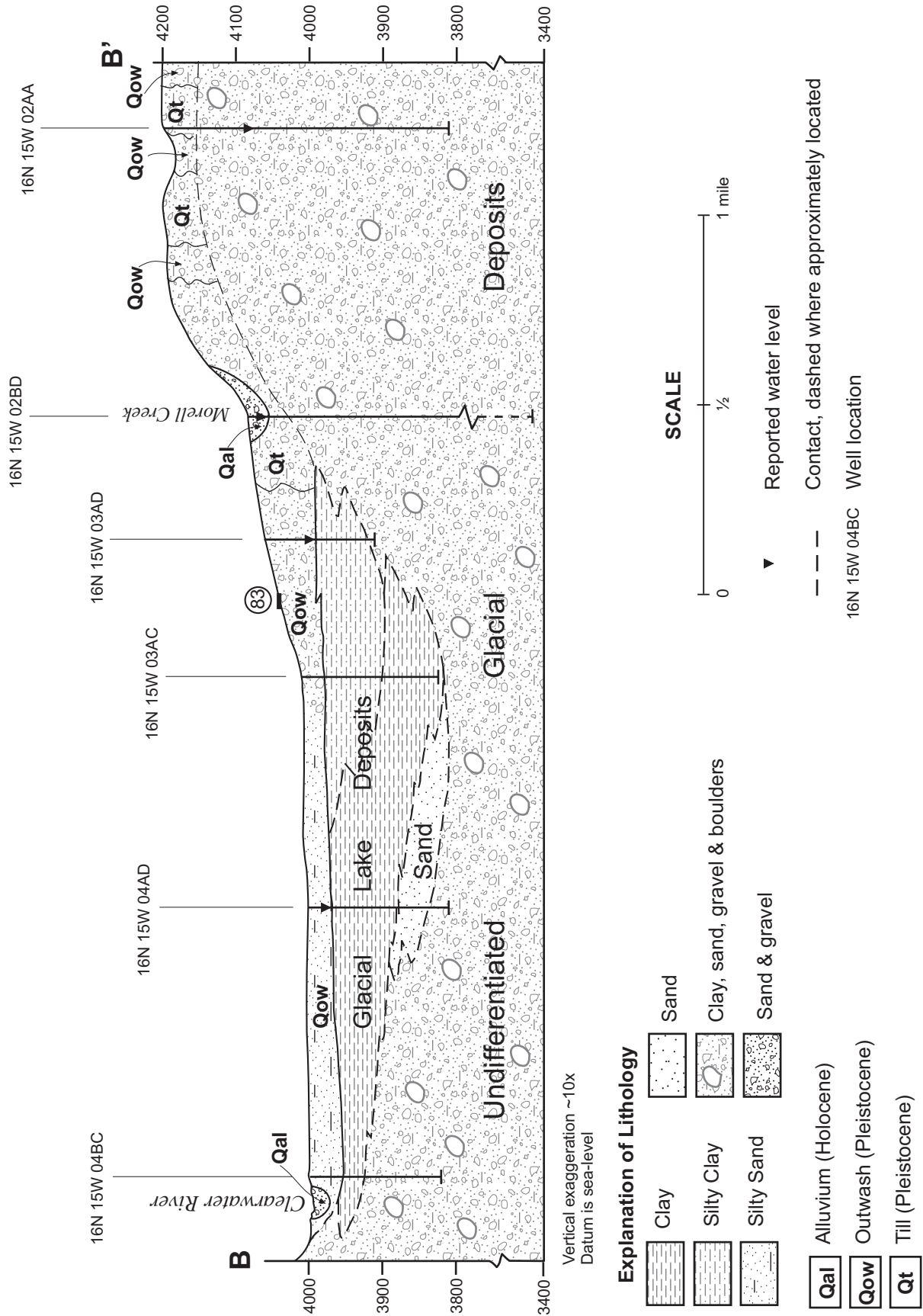

Figure 5. Generalized geologic cross section of the Seeley Lake area.

Most of the glacial debris in the study area was derived from the Clearwater Valley and Placid Creek Glaciers and their tributaries, which occupied the valley during the Pinedale Glaciation of the Pleistocene (10,000 to 70,000 years ago). These deposits are mapped as either glacial till (an unsorted deposit formed in place when ice melts), or as glacial outwash (material deposited by melt-water streams, resulting in better sorting). The glacial till also includes Glacial Lake Missoula deposits of silt and clay which are evident on some well logs but have not been noted in surface exposures. Water yields of wells penetrating only glacial till are low and many of these wells are considered dry. Permeabilities (a measure of the ease of movement of water through a material) for till typically range from 0.001 to 10 ft/day with an average of about 1 ft/day (Todd, 1967, and Davis & DeWiest, 1966).

The outwash occupies the valley bottoms and forms even-surfaced, gently sloping deposits commonly 10-15 feet above the alluvial floor of the Clearwater River and the lower reaches of Morrell and Trail Creeks. It consists of unconsolidated, moderately well-sorted silt, sand, granules, pebbles, and cobbles with minor subangular boulders (up to 1 foot in diameter). Published values of permeability for outwash deposits range from 1 to over 200,000 ft/day (Todd, 1967, and Davis & DeWiest, 1966). Permeabilities calculated for wells near Seeley Lake ranged from 2 to 620 ft/day from wells with yields of 6 to 12 gpm.

Glacial till veneers the valley margins and is differentiated into a valley facies and a foothill facies (Witkind & Weber, 1982). The valley facies consists of a heterogeneous mixture of

granules, pebbles, cobbles, and boulders (up to 5-8 feet in diameter) in a sandy, unconsolidated to partly consolidated matrix. It is found in distinctive hummocky moraines characterized by knob-and-kettle topography (comprised of small hills and depressions). The generally coarse nature of the material and the internally drained terrain limits runoff while allowing infiltration of precipitation and snowmelt to recharge ground water under the valley. The foothill facies is present along the lower flanks of the mountains and forms a veneer over bedrock. It differs from the valley facies in that it has a compact silt and clay matrix and is extensively mantled by colluvium. In the western half of the study area where the foothill facies is largely absent, the highest limit of glacial deposition is marked by a discontinuous veneer of glacial rubble. The rubble forms a lag deposit derived from erosion of the till.

Quaternary alluvium (Holocene) forms the youngest deposits in the Seeley Lake area and underlies the flood plains adjacent to the Clearwater River, Muddy Creek, and Trail Creek. The alluvium consists of well-bedded and well-sorted silt, sand, granules, pebbles, and some cobbles in a clayey matrix. It commonly overlies sand and gravel outwash deposits. Localized, low, broad alluvial fan deposits are present at the mouths of most of the small tributary streams. The material in the fans is partly consolidated and consists of silt, sand, granules, pebbles, and cobbles plus a few small boulders. Permeabilities are thought to be moderate to high, but these materials were not tested during the investigation.

Recharge/Discharge

Ground water in the valley and in the foothills is recharged by direct infiltration of rainfall and snowmelt, by surface and lateral subsurface flows off the bedrock valley walls, and by infiltration from streams, ponds, or lakes. Ground water discharges to Seeley Lake and the Clearwater River, to springs and wells, and is lost to the atmosphere by evaporation and transpiration.

Altitudes of water levels measured in wells, augmented with altitudes on Morrell Creek, Seeley Lake, and the Clearwater River were used to prepare the water-level contours shown on plate 1. All altitudes were estimated from the 7 ½ minute, 1:24,000 scale Seeley Lake West (contour interval 20 feet) and Seeley Lake East (contour interval 40 feet) topographic maps. Ground-water flow shown by the arrows is down-gradient at right angles to the water-level contours. Contours and flow directions on plate 1 show recharge in topographically high areas with discharge to the lake and river in topographic lows.

Seepage measurements were made at 2 sites on Morrell Creek, 4 sites along Seeley Lake, and 1 site along the Clearwater River (plate 1). The typical seepage measurement device is an end half of a 55 gallon drum. The open end is set into the bottom of the stream or lake, sealed, and a bladder (polypropylene bag) containing a known amount of distilled water is connected using surgical tubing to a hole through the closed end. After a predetermined amount of time (24 hours for this study) the change in the volume of water in the bladder is measured. Ground-water recharge or discharge to surface water is estimated by computing

the flow rate across the bottom of the stream or lake within the drum from the change in the volume of water in the bladder, the elapsed time, and the area covered by the drum. These measurements indicated a diversity of ground-water/surface water relations. Seepage volumes and rates for 24 hour periods are tabulated below.

SITE	GAIN/LOSS ml (milliliters)	SEEPAGE RATE cuft H2O/sqft/day	STREAM DIS- CHARGE
Morrell Creek – 16N15W02BCDBB	13 ml loss	-0.00069	278 cfs
Morrell Creek –16N15W11BDBBD	104 ml loss	-0.00553	95 cfs
Clearwater R. – 16N15W03CCDBD	0.5 ml gain	0.00001	
Seeley Lake – 16N15W03BACAD	0.0	0.00000	
Seeley Lake – 16N15W03CCDBD	26.6 ml gain	0.00034	
Seeley Lake - 16N15W03ACCAB	1.3 ml gain	0.00002	
Seeley Lake - 17N15W34DCACC	136.9 ml gain	0.00176	

Flow in Morrell Creek was gaged in conjunction with seepage measurements. The limited data in table 2 suggest that Morrell Creek was a losing stream and the Clearwater River and Seeley Lake were gaining at the time of the measurements. Information on gaining and losing reaches was used to augment information on flow directions as determined from the water-table map (plate 1).

Ground-Water Use

The primary use of ground water in the project area is for domestic purposes. Within the town of Seeley Lake, 1 domestic well, 1 lawn irrigation well, 2 monitoring wells (water levels or water quality), and a few abandoned wells were found. Outside of town, wells are used for domestic supply, stock watering, or irrigation of lawns and/or gardens.

Ground-Water Availability

All wells inventoried in the area (appendices C and D) draw water from glacial deposits. Yields for wells completed in glacial deposits vary widely depending on whether the wells penetrate outwash gravel or predominantly fine-grained till. Yields ranged from a field-measured 0.25 gallons per minute (gpm) to a GWIC-reported 150 gpm, with an arithmetic mean for all data of 14.7 gpm. Well depths in and near Seeley Lake range from 7 to 650 feet with a mean of 140 ft. The measured depths to water ranged from about 3 ft above to 400 ft below land surface with a mean depth of 42.6 ft below land surface.

Information on pumping rates and drawdowns were collected when the wells were inventoried. Water levels, discharge rates, water temperature, specific conductance, and pH were measured periodically while the wells were being pumped. These data are reported in Appendix C, Inventory Data.

Pumping rates and water levels measured during pumping and recovery were used to estimate transmissivities for 6 wells and storativities for 5 wells (table 3) using standard techniques such as those by Jacob, Theis, or others listed in Todd (1967). Permeabilities were calculated for wells for which lithologic information was available. Table 3 also includes transmissivities and permeabilities calculated from specific capacity (pumping rate divided by drawdown) from GWIC times a “rule of thumb” 267. At the bottom of table 3, transmissivities from aquifer test data are plotted against transmissivities from specific capacity data. By ignoring the one anomalously high estimated value (48,000) the method

Table 3. Seeley Lake aquifer test data summary

Location	Total depth (ft)	Pumping water level, PWL (ft)	Static water level, SWL (ft)	Pumping rate, Q (gpm)	Drawdown, DD (ft) = PWL - SWL	Specific capacity, SC (gpm/ftdd) = Q/DD	Transmissivity, T (ft ² /day) = SC x 200	Saturated thickness, H (ft) = TD - PWL	Permeability, K (ft/day) = T/H	T (ft ² /day) FROM AQUIFER TEST DATA	K (ft/day) FROM AQUIFER TEST DATA	Storativity, S
16N 15W 01 BABAA	70	54	13	15	41	0.37	73	16	4.6			
16N 15W 01 BBAAA	112	91	80	25	11	2.27	455	21	21.6			
16N 15W 01 BBACB	103	95	35	20	60	0.33	67	8	8.3			
16N 15W 01 BBBCA	100	55	45	15	10	1.50	300	45	6.7			
16N 15W 01 BBCAC	92	85	29	30	56	0.54	107	7	15.3			
16N 15W 01 BBCCA	100	30	20	7	10	0.70	140	70	2.0			
16N 15W 01 BCAAD	95	80	23.5	20	56.5	0.35	71	15	4.7			
16N 15W 01 BCCBA	119	70	14	40	56	0.71	143	49	2.9			
16N 15W 01 BDCCB	85	27	15	20	12	1.67	333	58	5.7			
16N 15W 01 CACCA	65	55	15	5	40	0.13	25	10	2.5			
16N 15W 01 CBAAB	88	84	15	5	69	0.07	14	4	3.6			
16N 15W 01 CBABC	115	32	20	30	12	2.50	500	83	6.0			
16N 15W 01 CCADB	160	101	99	5	2	2.50	500	59	8.5			
16N 15W 01 CCBCC	80	73	17	7	56	0.13	25	7	3.6			
16N 15W 02 AABBA	88	31.5	22.1	8	9.4	0.85	170	56.5	3.0	111	3.17	0.036
16N 15W 02 AADDD	90	36	25	15	11	1.36	273	54	5.1			
16N 15W 02 BCBBB	650	48	3.57	5	44.4	0.11	23	602	0.0			
16N 15W 03 CDCCAB	24	22	18	0.4	3.96	0.10	20	2.01	10.1			
16N 15W 03 DADBAA	120	62.71	62.7	12	0.05	240.00	48000	57.29	837.8	9324	622	
16N 15W 03 DBCCA 01	200	50	33	20	17	1.18	235	150	1.6			
16N 15W 03 DBCDB 01	60	50	33	17	17	1.00	200	10	20.0			
16N 15W 03 DDABCA	100	60	54.5	12.5	5.55	2.25	450	40	11.3			
16N 15W 10 BAADBA 01	60	17.2	16.7	12	0.5	24.00	4800	42.8	112.1	3195	71	0.15
16N 15W 11 ABCBD		91	76.2	2.1	14.8	0.14	28			7.95		0.062
16N 15W 11 ACABB	132	99.6	98.6	6	1.05	5.71	1143	32.4	35.3	525	16	0.2
16N 15W 12 BBBB	86	55.6	27.3	6.4	28.3	0.23	45	30.4	1.5	35.9	1.89	0.00044
17N 15W 33 BADAAB	135	42	14.6	21	27.4	0.77	153	93	1.7			
17N 15W 33 BDAAB	152	72	11.3	11.5	60.7	0.19	38	80	0.5			
17N 15W 33 BDDDA	269	72	8	20	64	0.31	63	197	0.3			
Lognormal means							156		5.1	281	21.2	0.031

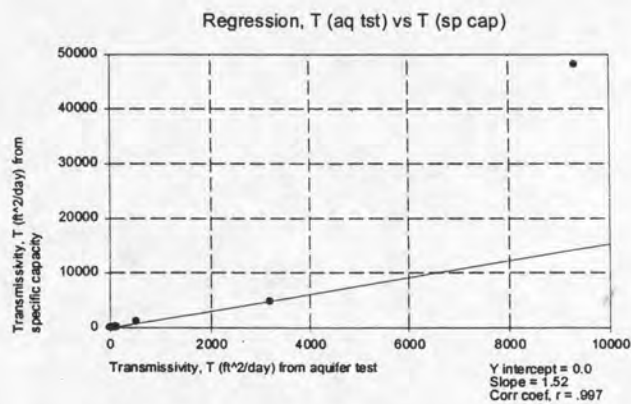

of estimation appears realistic. However because of the possibility of other anomalous values, only the transmissivities from the aquifer testing were used along with ground-water gradients from plate 1 to calculate rates of ground-water flow and to estimate potential nitrate loading from septic-tank effluent.

Water Quality

During this study, water samples were collected from 12 wells and 5 surface-water sites. Nine wells were for domestic purposes, one was unused and two were observation wells installed during a University of Montana study (Woessner, et al, 1996). Analytical data are contained in Appendix D: Ground-water quality data and Appendix B: Surface-water quality data. Analytical data from the University of Montana study (which concentrated on an area near the airport east of town and included 133 chemical analyses of ground-water samples from 30 wells) are also included in the data base. Sample sites are shown on plate 2.

Samples were collected and analyzed to meet two objectives: 1) obtain a set of background or baseline data on dissolved major constituents and trace elements; and 2) obtain enough data to allow statistical evaluation of the possibility of contamination from septic tank effluent.

Surface-Water Quality

Analyses of surface water collected in the Seeley Lake area show it to be a calcium bicarbonate type (figure 8). Samples were collected from 2 sites on Morrell Creek, 2 sites

Figure 6. Ionic percentages in surface water

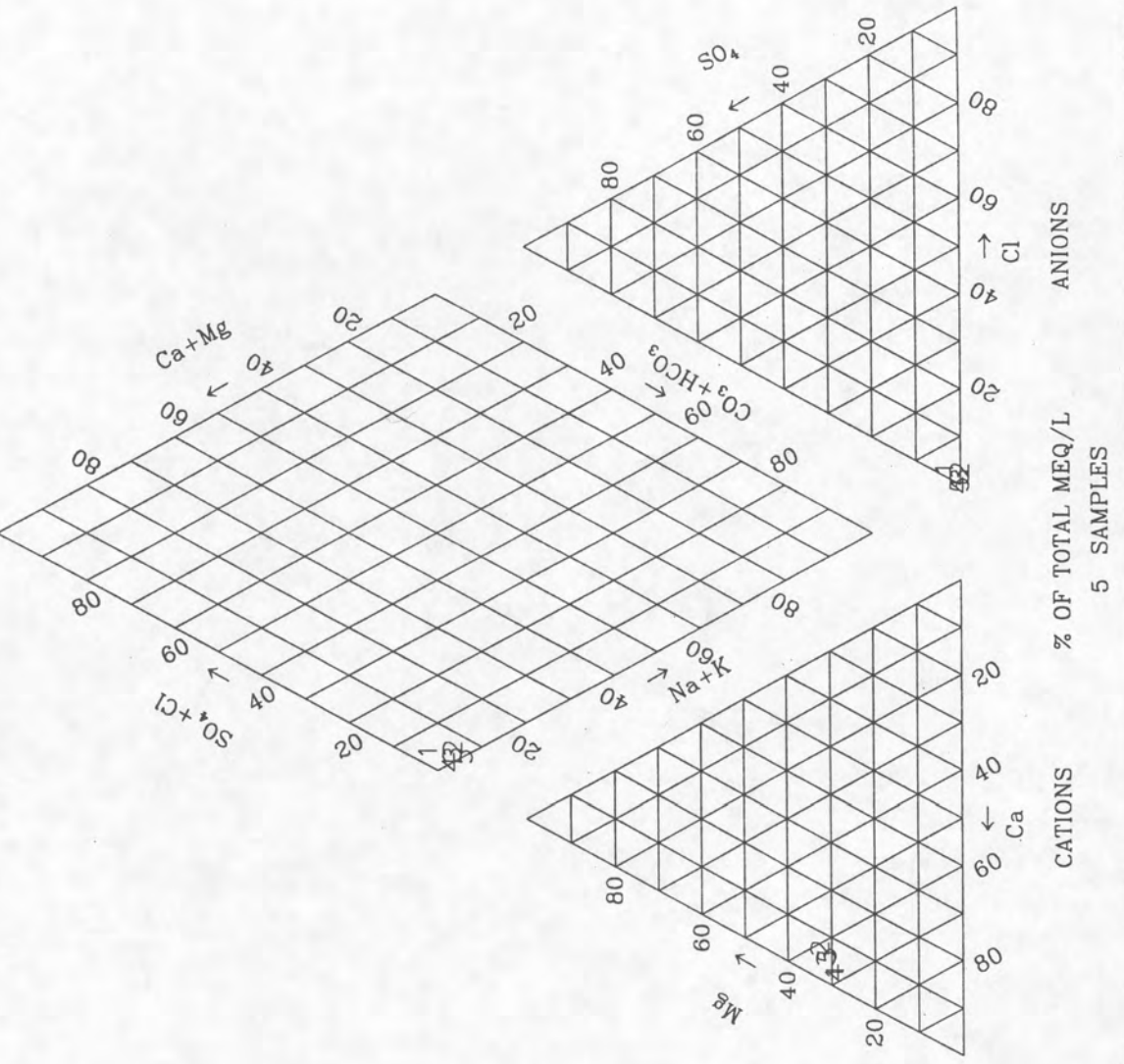

- 1 16N15W02BDBB
- 2 16N15W03ACCA
- 3 16N15W03CCDB
- 4 16N15W11BDB
- 5 17N15W34DCAC

MBMG
Seeley Lake
459

in Seeley Lake, and 1 site from the Clearwater River (plate 2). TDS levels range from 50 to 70 mg/L with an arithmetic mean of 61 mg/L. The value of 70 mg/L is from an irrigation system drawing water from Morrell Creek and the system may not have been totally flushed during sampling.

Ground-Water Quality

Ground-water quality is presented on tri-linear diagrams (figures 7 and 8) and Stiff diagrams (plate 3) to facilitate characterization and comparison of waters with respect to the major cations and anions. Plate 3 is also useful for evaluating areal water-quality trends. Ground water near Seeley Lake is dominated by calcium and bicarbonate ions, although one sample is a sodium bicarbonate-type water (161511ABCBD) and three samples have significant chloride concentrations (161503ABDC, 161503CDCC, and 161510BAAD). Samples collected during the University of Montana study are plotted on figure 8 (Seeley Lake ground water, University of Montana data) and are dominated by calcium and bicarbonate ions except for one site dominated by sodium (161501BBAA).

Trace element concentrations (Appendix D) are generally below detection limits but, where detected, are below drinking water standards except for one barium concentration of 2410 mg/L (maximum contaminant level 2000 mg/L) in well (16N15W03DABBBB). According to EPA, sources of barium include drilling wastes, metal refineries, and natural deposits (EPA,1998). Barium was analyzed in 16 samples and was detected in all of them.

Figure 7. Ionic percentages in ground water, MBMG samples

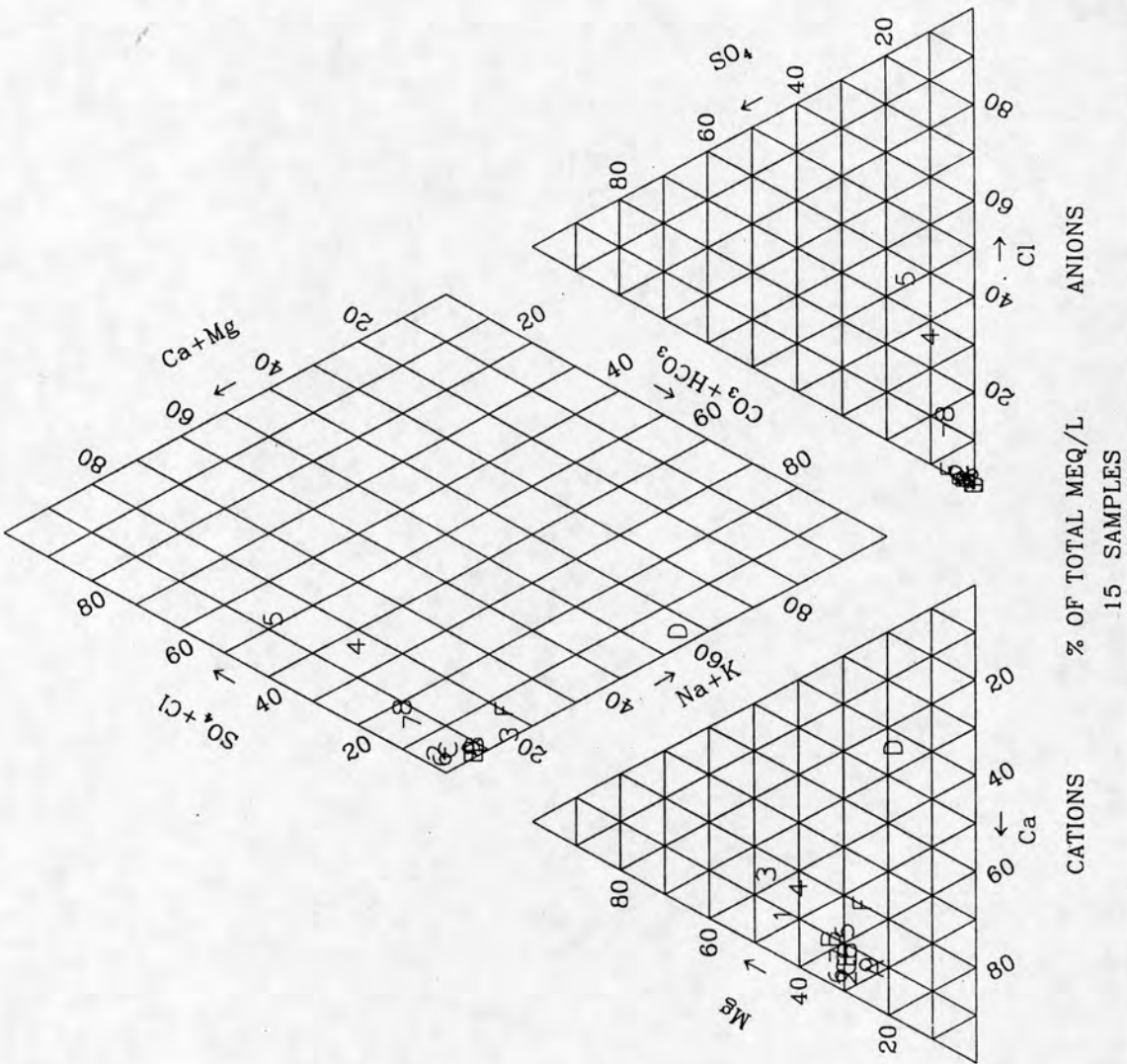

- 1 16N15W02ABCA
- 2 16N15W02BDBB
- 3 16N15W03AAAA
- 4 16N15W03ABDC
- 5 16N15W03CDCC
- 6 16N15W03DABB
- 7 16N15W03ADDB
- 8 16N15W10BAAD
- 9 16N15W12BBBB
- A 16N15W12BBBB
- B 16N15W02AAAD
- C 16N15W11ACCC
- D 16N15W11ABCB
- E 16N15W02AABB
- F 16N15W11ACAB

MBMG
Seeley Lake
459

Figure 8. Ionic percentages in ground water, U of M samples.

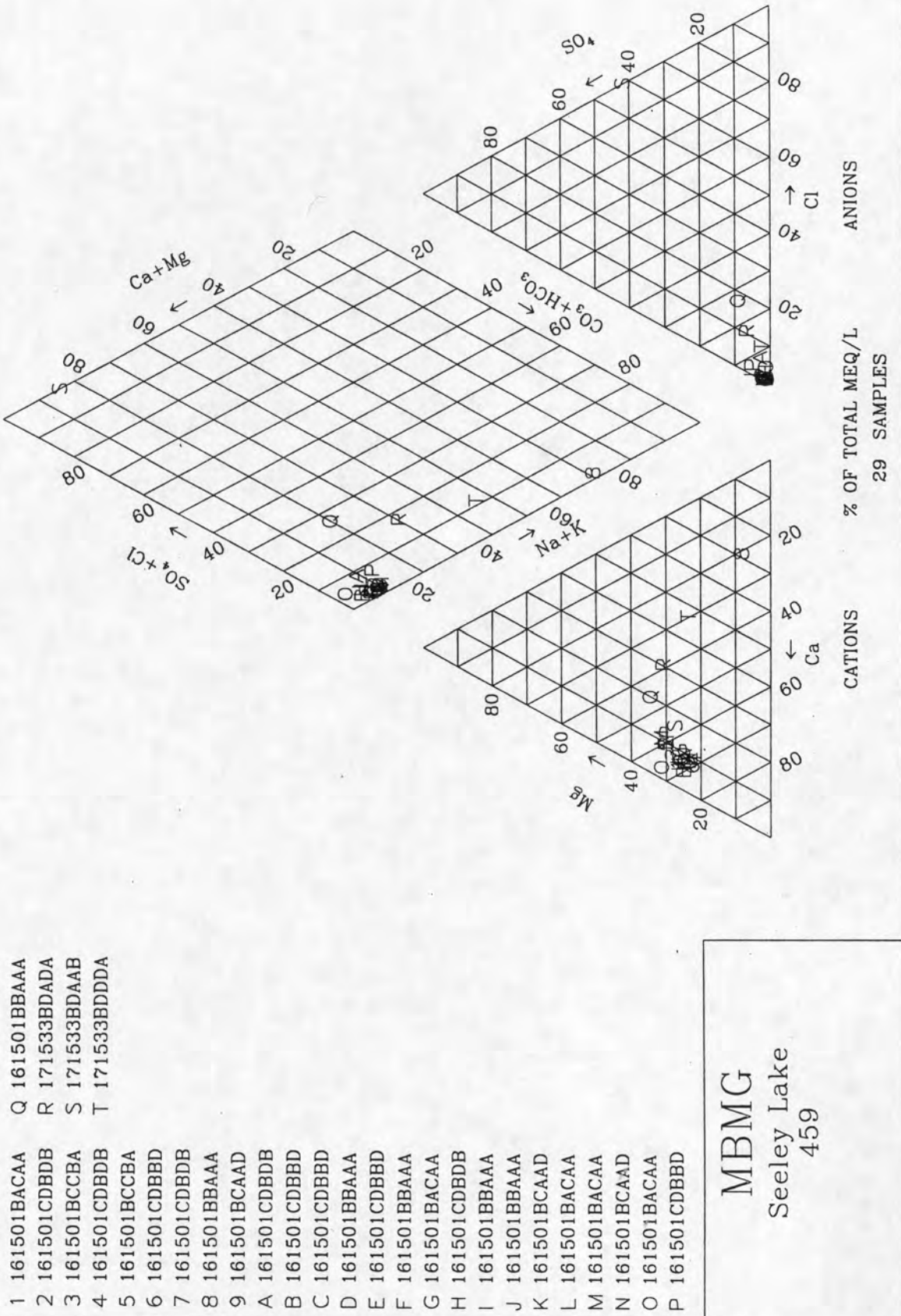

Concentrations ranged from 67 to 2411 mg/L with a median concentration of 180. Water from well 16N15W03DABBBB had very high turbidity from clay-sized particles, which is thought to be a source of the barium.

Ground Water: Influences of Septic Effluent

Peavy, and others, (1980) report that septic tank effluent typically contains the ranges of constituents shown in table 4.

Table 4. Typical Septic Tank Effluent Characteristics		
	Range	Mean
Total phosphate (PO4 as P) mg/l	6.25-30	11.6
Nitrate as N mg/l	0-0.1	0.026
Chloride mg/l	37-101	53

Most of the nitrogen released by septic tanks is in the form of ammonia and organic nitrogen (Madison, and others, 1984). Ammonia is converted to nitrate as follows:

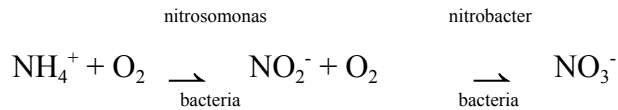

Nitrate is soluble and highly mobile under aerobic conditions, but under anaerobic conditions undergoes denitrification according to the following:

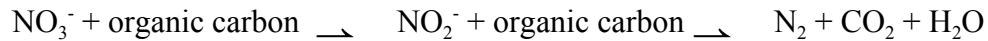

Anaerobic conditions are likely to be found in the fine-grained glacial sediments under the town of Seeley Lake, so most nitrate, although highly mobile, is probably attenuated by denitrification before traveling far from the source.

In ground water near Seeley Lake, nitrate concentrations (as nitrogen) range from below detection (detection limits range from 0.05mg/L to 0.25 mg/L depending on whether the sample was preserved with sulfuric acid) to 27 mg/L with a median value of 0.20 mg/L; see figure 9. Background (natural) nitrate (as N) and chloride concentrations appear to be below 1 mg/L and 10 mg/L, respectively. The US Geological Survey has suggested that nitrate-nitrogen concentrations greater than about 3 mg/L may be indicative of human sources (Madison, et al, 1984) but, the probability plot for nitrate (figure 10) suggests that, for Seeley Lake, ground-water concentrations greater than 1 mg/L may be appropriately considered impacted by human sources. As shown by figure 11 and on plate 2, most sample sites with nitrate concentrations greater than 1 mg/L correspond to chloride values greater than 10 mg/L. These sites are in or down-gradient from areas representing older developments such as the townsite of Seeley Lake or the airport area. The drinking water standard for nitrate is 10 mg/L as N as set by USEPA in the National Interim Primary Drinking-Water Regulations (USEPA, 1982).

Peavy, and others (1980) reported that many researchers have used a correlation between nitrate and chloride ions to document septic-tank pollution of ground-water supplies. Both chloride and nitrate are mobile in the subsurface environment and both are found in septic-tank effluent. As shown on the plot of nitrate vs chloride (figure 11), there is a positive correlation (that is, chloride increases as nitrate increases), suggesting contamination of ground water by septic tank effluent. The correlation coefficient for a least-squares linear regression of average chloride concentrations against nitrate is 0.8 (1 = perfect). Data for well

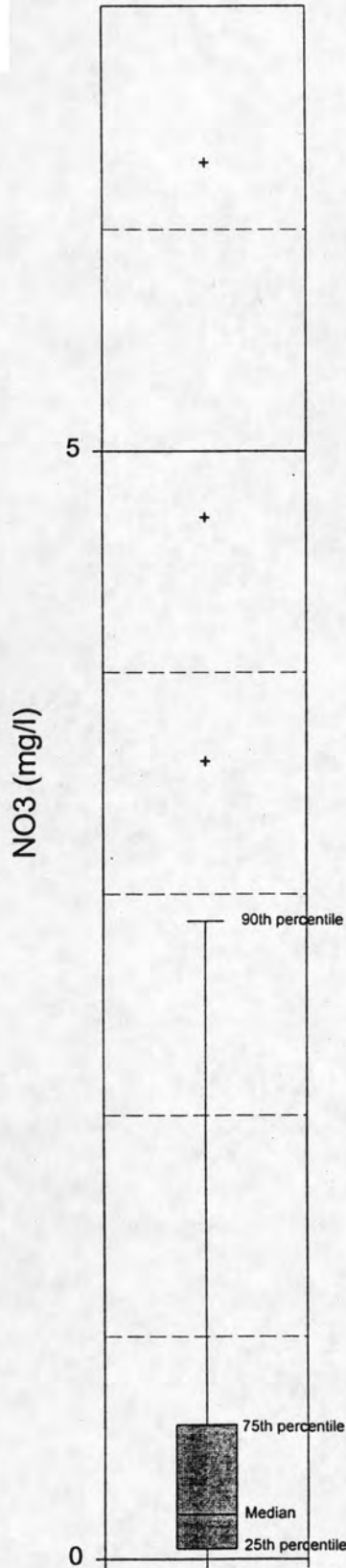

Figure 9. Nitrate in Seeley Lake area groundwater

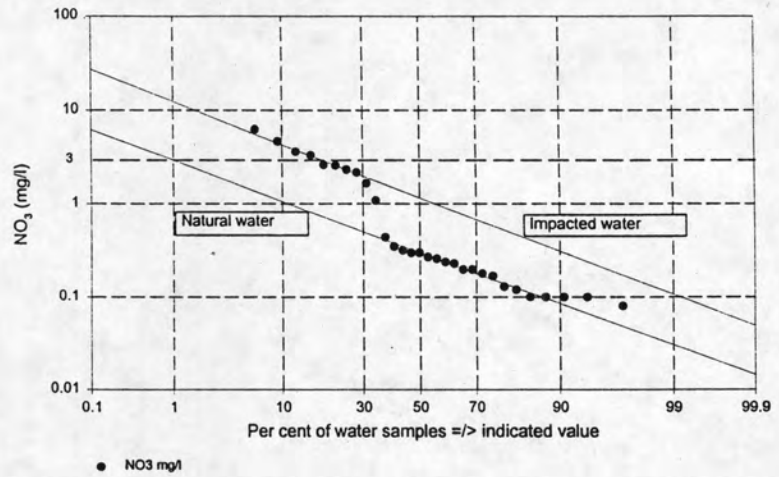

Figure 10. Probability plot - nitrate in Seeley Lake area groundwater

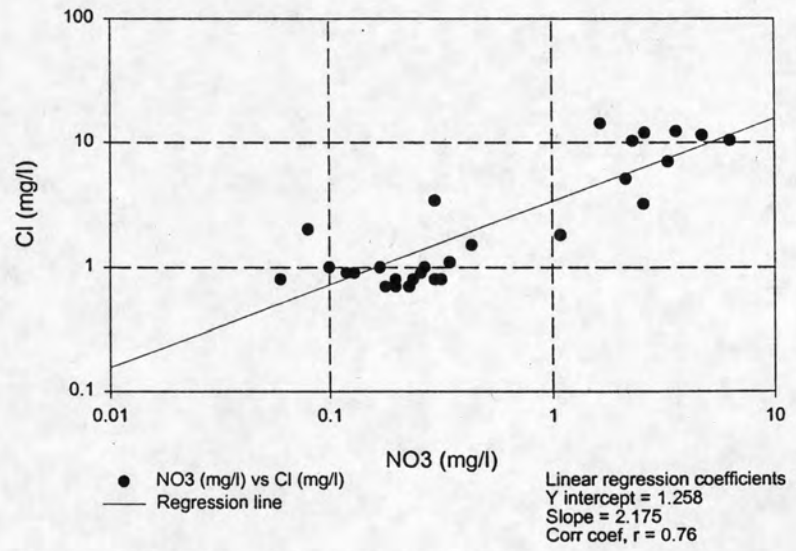

Figure 11. Nitrate vs chloride, Seeley Lake groundwater.

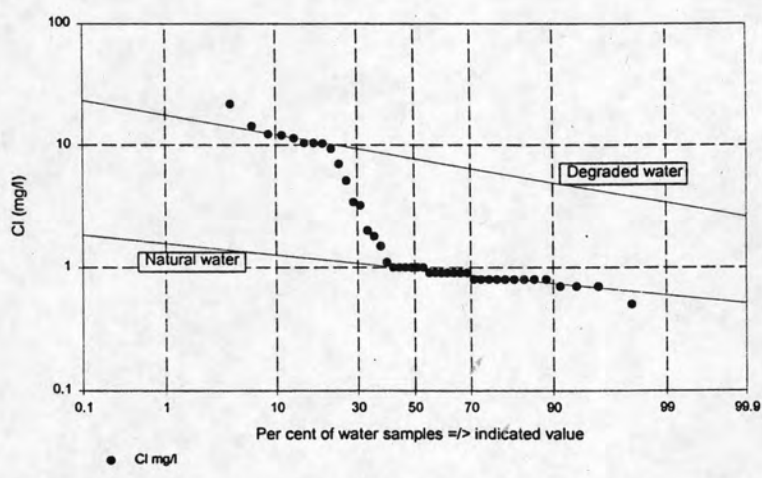

Figure 12. Probability plot - chloride in Seeley Lake area groundwater

16N15W03CDCCAB with anomalously high values of chloride and nitrate (41 and 27 mg/L, respectively) were not included in the regression. Probability plots of nitrate and chloride concentrations in Seeley Lake ground water (figures 10 and 12) also suggest contamination because two populations are evident on each plot. The lower line on each plot is interpreted to represent natural ionic concentrations, and the higher concentrations of the upper lines represent human impacts. All wells which were sampled are completed in glacial deposits, which, for the purposes of this discussion are treated as one hydrogeologic unit. Measured or reported well depths range from 24 to 245 feet. Depths are not known for 10 wells which were sampled. The relations between well depth and ionic concentrations are discussed later. Only one nitrate value exceeded the drinking water standard of 10 mg/L (as N) and that was a value of 27 mg/L in an unused well contaminated by sawdust.

Tri-linear diagrams in figures 7 and 8 suggest little or no possibility of cation exchange, where calcium and magnesium are exchanged for sodium in a natural softening process, and sulfate reduction, where sulfate in the presence of anaerobic bacteria is reduced to sulfide. If these processes were occurring near Seeley Lake, as ground water moved down-gradient, concentrations of calcium, magnesium and sulfate would be expected to decrease in proportion to sodium and bicarbonate. No such pattern can be identified in looking at these data areally. No correlation could be found between calcium and sodium concentrations, but magnesium shows a weak tendency (correlation coefficient = 0.09) to increase as sodium concentrations increase (figure 13) and sulfate increases slightly as bicarbonate increases

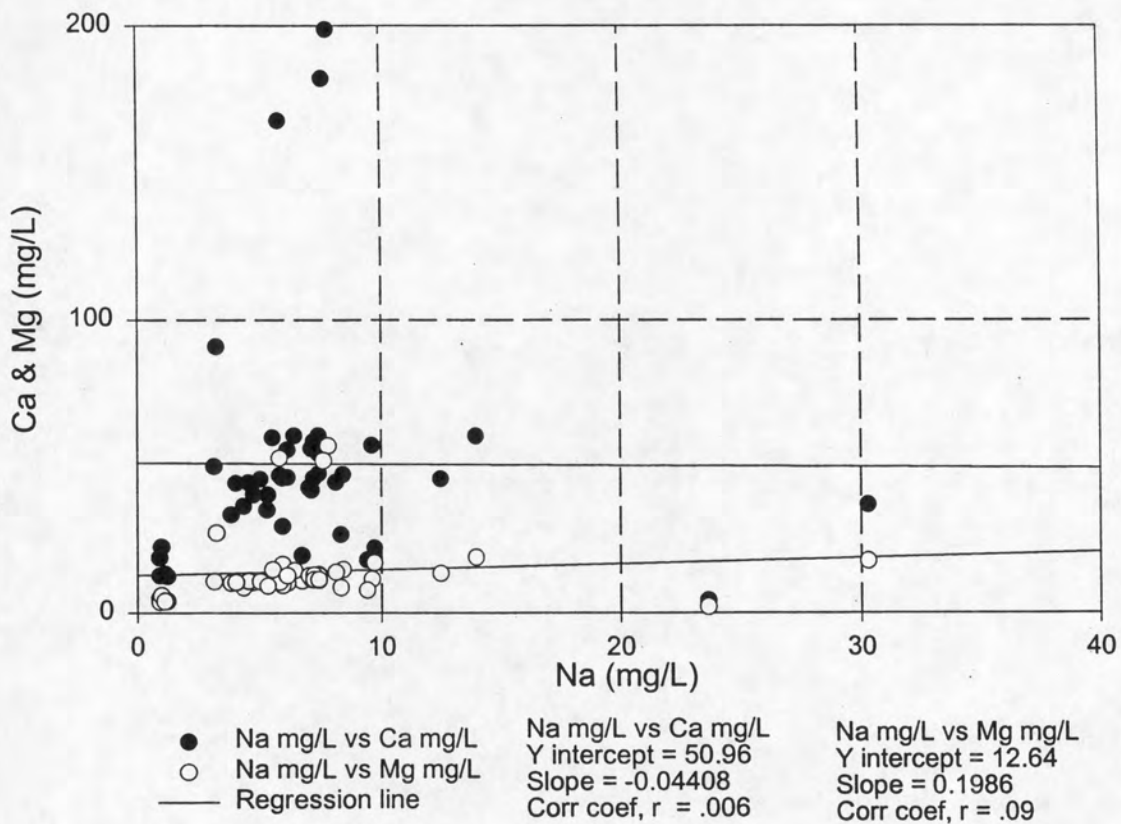

Figure 13. Sodium vs calcium & magnesium in Seeley Lake water samples

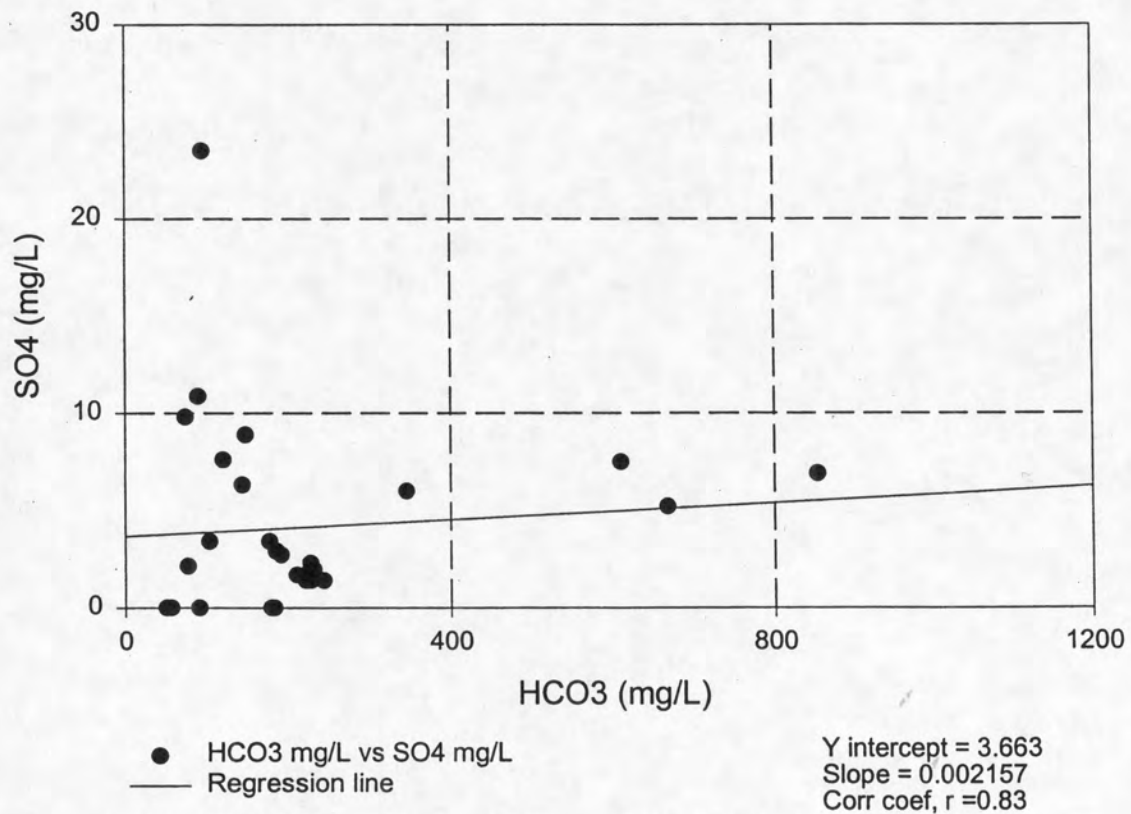

Figure 14. Bicarbonate vs sulfate in Seeley Lake water samples

(figure 14). Concentrations of calcium, magnesium, sodium, bicarbonate, chloride and sulfate were all found to decrease with depth (figure 15).

Septic-tank information from Missoula County files (Tandberg, 1997) and the site inventory are presented in Appendix E, and locations are shown on plate 4 for 546 septic systems. The most intense current development is concentrated east and south of town in sections 1, 2, 11, and 12. Development in these areas is expected to have little impact on lake water quality because ground water from these areas discharges primarily to the Clearwater River and Morrell Creek downstream from the lake (plate 1). Additional development in section 3, T16N, R15W, has the potential to impact the lake, but most lakeshore lots have already been developed, so without further subdivision of those lots, additional construction opportunities are limited. Development in sec 35, T17N, R15W, has the potential to impact the lake because ground water from that section ultimately discharges to Seeley Lake as shown by the flow-direction arrows on plate 1. Failure of existing systems without additional construction also could threaten surface water quality through release of untreated sewage, or release of effluent at the surface.

The processes of nitrification/denitrification can affect the concentration of nitrate in ground water, usually by causing a reduction in nitrate concentration. A literature search suggests that these reactions are not fully understood and, therefore, are difficult to quantify. To simplify the calculations, nitrification/denitrification was ignored in calculating the theoretical nitrate loading (increase in concentration) resulting from septic tank effluent for

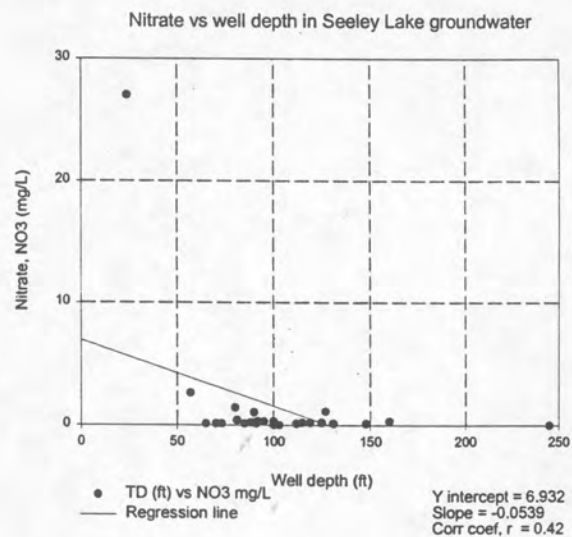
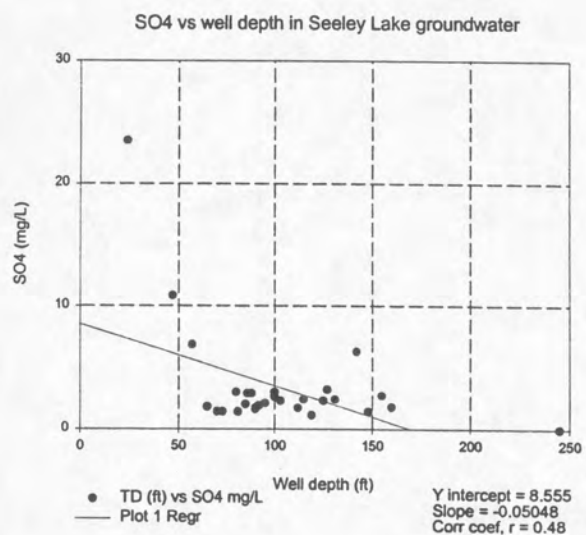
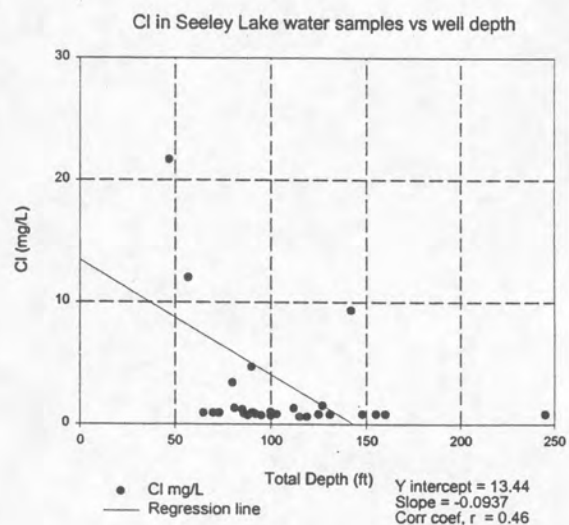
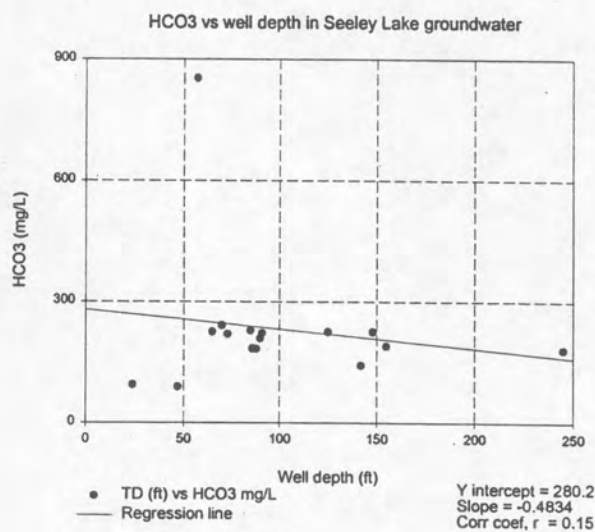
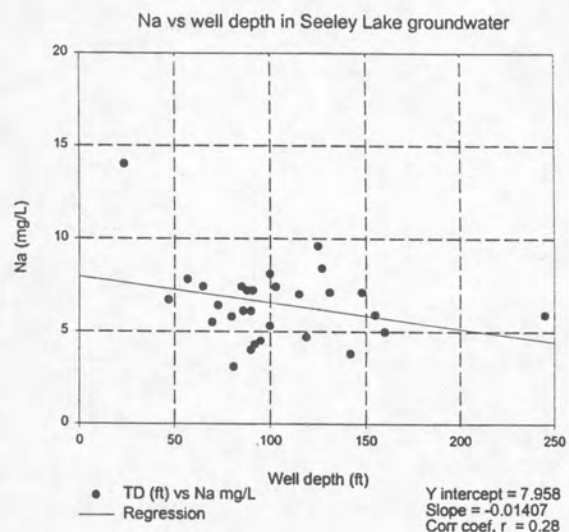
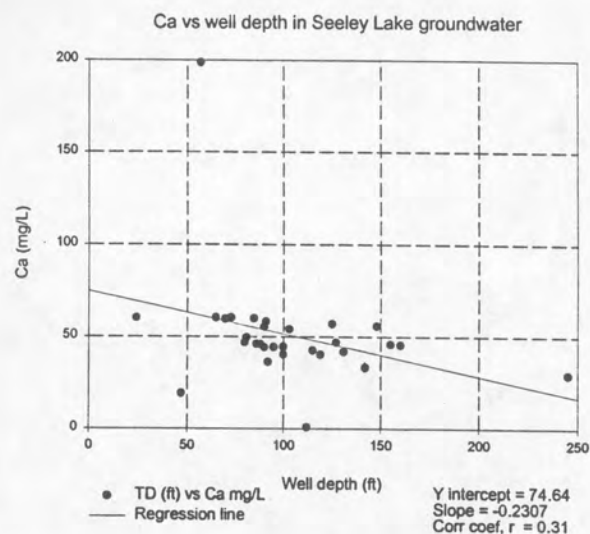

Figure 15. Ionic concentration vs well depth

flow paths defined by the flow-direction arrows shown on plate 1. Information needed for these calculations includes the amount of nitrate which a septic tank releases to ground water, transmissivity of the aquifer, and the hydraulic gradient. Ver Hey and Woessner (1987) report 8.3 and 8.7 kilograms per year of nitrogen reaching ground water under two systems in the Missoula area. Similar data are not available for the Seeley Lake area. An average of 8.5 kg/yr along with the median transmissivity of 318 square feet per day from table 3, septic tank densities from plate 4, and gradients from plate 1 were used in the calculations summarized in table 5. The flow paths used in the calculations are shown on plate 1.

The longest and shortest probable travel times have also been calculated (table 5) for each flow path. The longest times were assumed to be from the most up-gradient septic system in a flow path to a discharge area. End points are: 1) for the northern flowpath, from 16N15W03AAA to Seeley Lake at 16N15W03ACA; 2) for the middle flow path, from 16N15W02AAA to Morrel Creek at 16N15W02CDB; and 3) for the southern flow path, from 16N15W02AAA to Morrel Creek at 16N15W011BAB. The shortest flow paths were assumed to be 100 feet, the regulatory setback distance for septic systems from streams or lakes.

Table 5. Seeley Lake nitrate-loading calculations.			
Equations Used:			
Discharge (Q) = TWI			
Average hydraulic gradient (I) = head loss / flowpath length (D)			
Estimated NO ₃ loading (L) = (number of septic tanks) x (amount of NO ₃ per tank reaching ground water)			
Estimated increase in NO ₃ concentration in ground water = QL			
Estimated travel time (T) = D/KI			
Estimated Input Values:			
Median Transmissivity (T) = 318 ft ² /day			
Median Permeability (K) = 37 ft/day			
NO ₃ from septic tanks = 8.5 kg/year = 8,5000,000 mg/year			
Input Parameters	North Flow Path, 1 (15N15W03AAA to Seeley Lake)	Middle Flow Path, 2 (16N15W02AAA to Morrel Creek)	South Flow Path, 3 (16N15W02AAA to Morrel Creek)
Flowpath Width (W)	3400 feet	3850 feet	4050 feet
Discharge (Q)	38614ft ³ /day (399,091,772 liters/year)	15692 ft ³ /year (162,182,501 liters /year)	29951 ft ³ /day (309,555,451 liters/year)
Number of septic tanks	118	140	97
Estimated NO ₃ loading (L)	1003 kg/year	1190 kg/year	824.5 kg/year
Estimated increase in NO ₃ concentration in ground water	2.5 mg/L	7.3 mg/L	2.7 mg/L
Flowpath length (D)	2000 feet	5000 feet	8250 feet
Estimated travel time	4.1 years (1514 days)	28.9 years (10,543 days)	26.3 years (9588 days)
Estimated travel time for 100 feet	75 days	211 days	116 days

Nitrate data presented in figure 10 suggest that ground water is being degraded by septic tank effluent. Chloride and nitrate concentrations are plotted against sample date on figure 16a for all samples, and for three wells sampled in 1993, 1994, and 1997 (figures 16b, 16c, and 16d). Chloride concentrations on figure 16a show a weak tendency to increase (r = 0.4) but, for wells 16N15W02AAACB, 16N15W03ABDCB, and 16N15W03DABBB there is no significant change with time. Nitrate concentrations on figure 16a show a weak tendency to increase (r = 0.5) as do the data on Figure 16c. No significant change can be discerned from figures 16b and 16d.

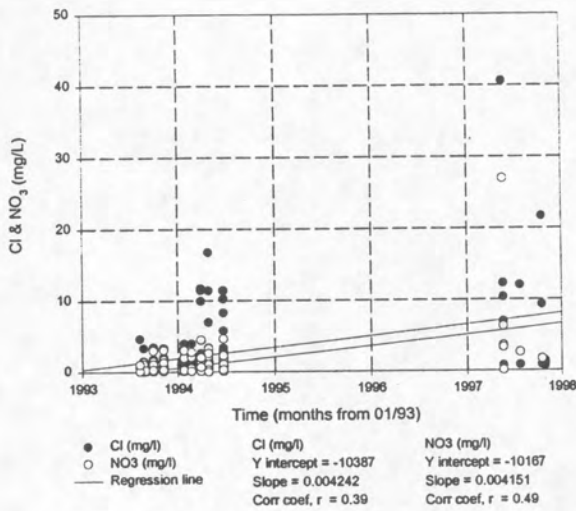

Figure 16a. Chloride and nitrate (all data) vs sample date.

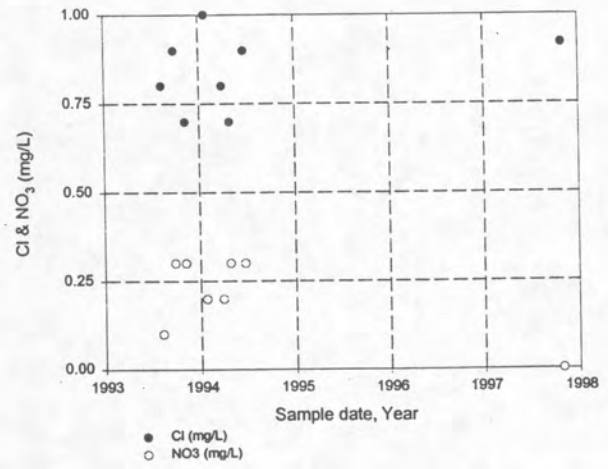

Figure 16b. Chloride and nitrate vs sample date, 16N15W02AAACB.

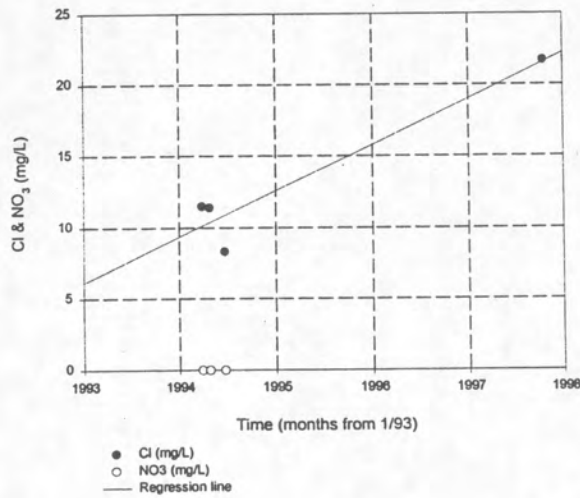

Figure 16c. Chloride and nitrate vs sample date, 16N15W03ABDCB.

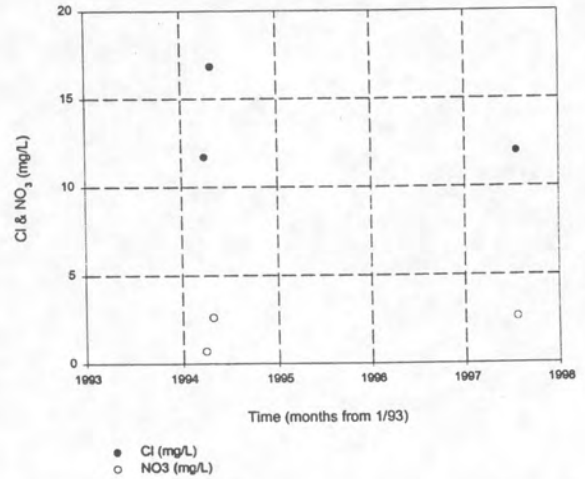

Figure 16d. Chloride and nitrate vs sample date, 16N15W03DABBB.

Figure 16. Chloride and nitrate concentrations vs sample date.

The calculated nitrate loading values in table 5 are in general agreement with the increases shown in figure 10. Only limited development is likely in the north flow path, because Section 35 is National Forest and most of the lots in town have been developed. Therefore, unless ownership of Section 35 changes, nitrate loading of ground water flowing toward the lake will not likely change much in the future for that flow path. Continued development along the middle and southern flow paths has the potential to increase nitrate concentrations in ground water moving toward the Clearwater River and Morrell Creek. Although processes such as denitrification and adsorption will reduce nitrate concentrations somewhat, continued development will likely cause some exceedances of the drinking water standard of 10 mg/L (as N) in the future.

Conclusions and Recommendations

Analytical data for nitrate and chloride in ground water at Seeley Lake suggest that ground water is being degraded by septic-tank effluent. At present the only exceedance of drinking water standards is an unused well which has been contaminated by sawdust. Additional development along the shore of the lake would likely result in septic-tank effluent reaching the lake, but the resulting subtle water-quality changes might not be directly measurable. Indication of degradation might be a gradual increase in algae along shore and decreased visibility in the water. Current development east and south of the town of Seeley Lake in sections 1, 2, 10, 11, or 12, T16N, R15W is not thought to be a threat to water quality of the lake because ground water under these sites drains toward the Clearwater River or Morrell

Creek.

To monitor future changes in ground water under the town of Seeley Lake, establishment of a monitoring well network is recommended. There are few wells in town and none next to the lake, which is a ground-water discharge area as well as the source for the water-district supply. Suggested locations for monitoring wells are shown on figure 17. The sites have been prioritized according to their potential to detect water quality changes. Prioritization took into account ground-water flow directions and up-gradient levels of development, existing and anticipated. For the first year, the wells should be sampled quarterly. The first sample from each well should be for a complete analysis: major cations and anions including nitrate plus nitrite, metals, total petroleum hydrocarbons, and total halogens. Subsequent samples should be analyzed for nitrate, nitrite, and chloride. Samples should be collected after removal of three well-bore volumes of water. Field parameters should be measured during sampling. After collection of the first year of data, sampling frequency can probably be decreased to annual samples unless changes are detected.

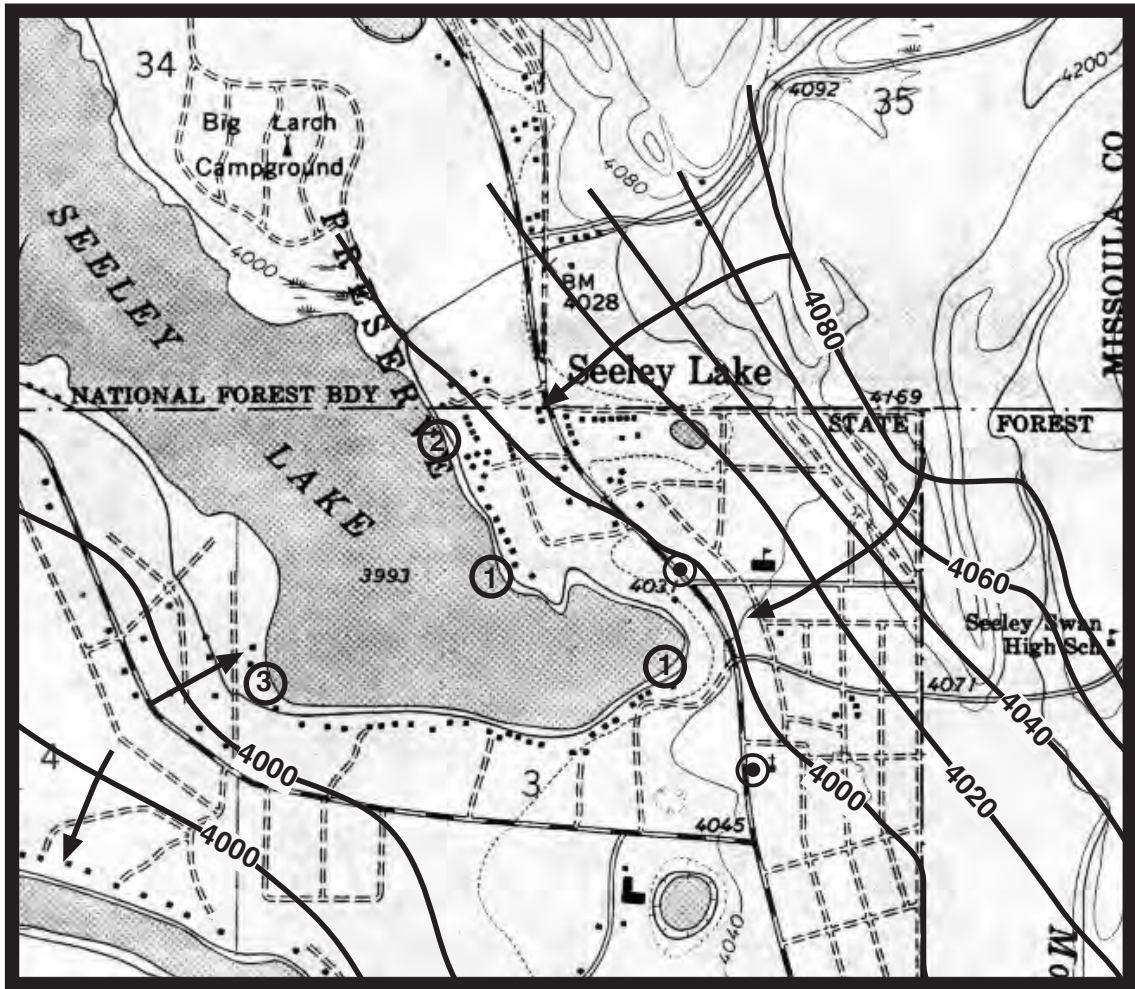

1 mile
SCALE

- ⊙ Existing monitoring well
- ① Proposed monitoring well, number indicates priority
- ~ Water table elevation contour
- ↘ Ground-water flow direction



Figure 17. Proposed monitoring well locations.

References:

EPA, 1998, Current Drinking Water Standards: Office of Ground Water and Drinking Water, query on 10/12/98 of <http://www.epa.gov/OGWDW/wot/apa.html>.

Fetter, C. W. Jr., 1980, Applied Hydrogeology: Charles E. Merrill Publishing Company, Columbus, Toronto, London, Sydney, 488 pp.

Madison, R. J., Brunett, J. O., 1984, Overview of the Occurrence of Nitrate in Ground Water of the United States – National Water Summary 1984: United States Geological Survey Water-Supply Paper 2275.

Mudge, M.R., Earhart, R.L., Whipple, J.W., and Harrison, J. E., 1982, Geologic and structure maps of the Choteau 1° x 2° quadrangle, western Montana: Montana Bureau of Mines and Geology Atlas 3-A, 1:250,000, 2 sheets.

Noble, R.A., Bergantino, R.N., Patton, T. W., Sholes, B.C., Daniel, Faith, and Schofield, Judeykay, 1982, Occurrence and characteristics of ground water of Montana—Volume 2, The Rocky Mountain Region: Montana Bureau of Mines and Geology Open-File Report 99, 132p.

Peavy, H. S., Brawner, C. E., Stark, P. E., 1980, The effects of non-sewered subdivisions on ground-water quality: Dept of Civil Engineering and Engineering Mechanics, Montana State Univ. (for the Water Quality Bureau, MT Dept. of Health & Environmental Science), 80-623175.

Rogers, G. S., 1917, Chemical Relations of the Oil-Field Waters in San Joaquin Valley, California: U. S. Geological Survey Bulletin 653, 119 pp.

Todd, D. K., 1967, Ground Water Hydrology: John Wiley and Sons, Inc., 336 pp.

USGS, 1998, <http://waterdata.usgs.gov/nwis-w/MT/data.components/hist.cgi?statnum=12339450>

USEPA, 1982, Maximum contaminant levels (subpart B of part 141, National interim primary drinking-water regulations): U.S. Code of Federal Regulations, Title 40, parts 100 to 149, revised as of July 1, 1982, p. 315-318.

Ver Hey, M. E., and Woessner, W. W., 1987, Documentation of the Degree of Waste Treatment provided by Septic Systems, Vadose Zone and Aquifer in Intermontane Soils Underlain by Sand and Gravel: On-site Wastewater Treatment Vol 5, American Society of Agricultural Engineers Publication 10-87.

Western Regional Climate Center, 1998, Average Annual Precipitation, Montana, Period:1961-1990: Precipitation Maps for the Western U.S., www.wrcc.dri.edu/pcpn/mt.gif

Witkind, I. J., and Weber, W.M., 1982, Reconnaissance geologic map of the Big Fork-Avon environmental study area, Flathead, Lake, Lewis and Clark, Missoula, and Powell Counties, Montana: U.S. Geological Survey Miscellaneous Investigations Series Map I-1380, scale 1:125,000.

Witkind, I. J., 1977, Preliminary map showing surficial deposits in the Seeley Lake West quadrangle, Missoula County, Montana: U.S. Geological Survey Open-File Report 77-201, 1:24,000.

Witkind, I. J., 1977, Preliminary map showing surficial deposits in the Seeley Lake East quadrangle, Missoula and Powell Counties, Montana: U.S. Geological Survey Open-File Report 77-202, 1:24,000.

Woessner, W. W., King, J., Lambert, S., Michalek, T., and Hinman, N., 1996, Cumulative Effects of Domestic Sewage Disposal on Groundwater of Missoula County: An Analysis of Carrying Capacity. Report by UM to Missoula County Commissioners.

Appendix A

Surface-water inventory data

Seeley Lake surface-water data - inventory data

LOCATION	DATE INVENTORIED	PUMP?	SURFACE ELEVATION (ft)	FLOW (cfs)	WATER USE	SAMPLE SOURCE	SAMPLE DATE	SAMPLE TAKEN	MBMG QW #	MBMG SITE #
16N 15W 02 BCDBB	18-Aug-97	N/A	4060	278		MORRELL CREEK		N		
16N 15W 02 BDBBC	21-Jul-97	Y	4100		IRRIGATION	MORRELL CREEK	21-Jul-97	Y	1998Q0060	M:161806
16N 15W 02 BDBBC	6-Dec-96	Y	4100		IRRIGATION	MORRELL CREEK		N		M:161806
16N 15W 03 ACCAD	19-May-97	Y	4001		DOMESTIC	SEELEY LAKE	19-May-97	Y	1997Q0810	M:160817
16N 15W 03 ACCAD	18-Jun-96	Y	4001		DOMESTIC	SEELEY LAKE		N		M:160817
16N 15W 03 CCDBDD	20-Aug-97	N/A	3995			CLEARWATER RIVER	20-Aug-97	Y	1998Q0212	M:162434
16N 15W 11 BDBBD	20-Aug-97	N/A	4007	95		MORRELL CREEK	20-Aug-97	Y	1998Q0213	M:162437
17N 15W 34 DCACD	20-Aug-97	N/A	3997			SEELEY LAKE	20-Aug-97	Y	1998Q0206	M:162433

Appendix B

Surface-water quality data

Seeley Lake surface-water data - parameters

LOCATION	SAMPLE DATE	SAMPLE SOURCE	TDS CALC'D (mg/l)	TDS SUM OF DIS CONST (mg/l)	FIELD SC ($\mu\text{mho/cm}$)	LAB SC ($\mu\text{mho/cm}$)	FIELD pH	LAB pH	HARDNESS AS CaCO3 (mg/L)	ALKALINITY AS CaCO3 (mg/L)	RYZNAR STABILITY INDEX	LANGLIER SAT IND	SAR	AIR TEMP (deg C)	WATER TEMP (deg C)
16N 15W 02 BDBBC	21-Jul-97	CREEK	70.29	108.86	89.2	136.	7.02	8.1	66.86	62.33	8.77	-0.33	0.05	33.	13.5
16N 15W 03 ACCAD	19-May-97	LAKE	52.23	77.56	83.5	76.2	7.33	7.24	47.43	40.94	10.35	-1.55	0.08	18.3	8.5
16N 15W 03 CCDBDD	20-Aug-97	RIVER	49.86	77.82	104.8	92.	6.57	7.53	46.44	45.19	9.97	-1.22	0.06	19.5	20.
16N 15W 11 BDB	20-Aug-97	STREAM	79.62	125.19	157.5	144.	6.94	7.87	79.56	73.65	8.7	-0.41	0.05	20.	10.5
17N 15W 34 DCACD	20-Aug-97	LAKE	52.02	80.23	104.	94.	6.75	7.68	49.01	45.6	9.76	-1.04	0.07	22.	21.5

Seeley Lake surface-water data - major elements

LOCATION	SAMPLE DATE	SAMPLE SOURCE	MBMG QW #	Ca (mg/L)	Mg (mg/L)	Na (mg/L)	K (mg/L)	Fe (mg/L)	Mn (mg/L)	SiO2 (mg/L)	HCO3 (mg/L)	CO3 (mg/L)	Cl (mg/L)	SO4 (mg/L)	NO3 (mg/L)	F (mg/L)	PO4 (mg/L)
16N 15W 02 BDBBC	21-Jul-97	CREEK	98Q0060	18.7	4.9	0.89	0.2	0.004	<.002	5.20	76		0.82	2.14	<.05		<.05
16N 15W 03 ACCAD	19-May-97	LAKE	97Q0810	12.4	4.	1.2	0.5	0.038	<.004	8.60	49.92		0.88	<2.5	<.05		<.05
16N 15W 03 CCDBDD	20-Aug-97	RIVER	98Q0212	12.5	3.7	0.911	0.353	0.038	0.004	4.70	55.1		0.51	<2.5	<.25		<.05
16N 15W 11 BDB	20-Aug-97	STREAM	98Q0213	22.3	5.8	0.976	0.406	0.004	<.002	5.90	89.8		<.5	<2.5	<.25		<.05
17N 15W 34 DCACD	20-Aug-97	LAKE	98Q0206	13.2	3.9	1.1	0.52	0.01		5.90	55.6		<.5	<2.5	<.25		<.05

Seeley Lake surface-water data - trace elements

LOCATION	SAMPLE DATE	SAMPLE SOURC	MBMG QW #	Al (ug/L)	Sb (ug/L)	As (ug/L)	Ba (ug/L)	Be (ug/L)	B (ug/L)	Br (ug/L)	Cd (ug/L)	Cr (ug/L)	Co (ug/L)	Cu (ug/L)	Pb (ug/L)	Li (ug/L)	Mo (ug/L)	Ni (ug/L)	NO2 as N (ug/L)	P tot dis (ug/L)	Se (ug/L)	Ag (ug/L)	Sr (ug/L)	Ti (ug/L)	Va (ug/L)	Zn (ug/L)	Zr (ug/L)
16N 15W 02 BDBBC	21-Jul-97	CREEK	98Q0060	<30	<2	<1	111.8	<2	<30	<25	<2	<2	<2	<2	<2	<6	<10	<2		<2	<2	<1	35	<10	<5	2.2	<20
16N 15W 03 ACCAD	19-May-97	LAKE	97Q0810	<30	<3	<2	62.2	<2	<30	<25	<2	<2	<2	3.3	<2	<10	<10	<2	<.05	<2	<1	<1	19	<10	<10	14.4	<20
16N 15W 03 CCDBDD	20-Aug-97	RIVER	98Q0212	<30	<3	<2	66.3	<2	<30	<25	<2	<2	<2	3.5	<2	<6	<10	2.2		<2	<1	<2	19	<10	<5	<2	<20
16N 15W 11 BDB	20-Aug-97	STREAM	98Q0213	<30	<3	<2	126.7	<2	<30	<25	<2	2.9	<2	<2	<2	<6	<10	3.1		<2	<1	<2	38	<10	<5	<2	<20
17N 15W 34 DCACD	20-Aug-97	LAKE	98Q0206	<30	<3	<2	65.3	<2	<30	<25	<2	<2	<2	<2	<2	<6	<10	2.1		<2	<1	<2	23	<10	<5	<2	<20

Appendix C

Ground-water inventory data

Seeley Lake ground-water inventory data

LOCATION	DATE INVENTORIED	DATE DRILLED	PUMP?	SURFACE ELEVATION (ft)	TOTAL DEPTH (ft)	BOTTOM ELEVATION (ft)	CASING DIAMETER (in)	PUMPING WATER LEVEL (ft)	STATIC WATER LEVEL (ft)	STATIC WATER LEVEL (ft)	LEVEL ELEVATION (ft)	PUMPING RATE, Q (gpm)	WATER USE	SAMPLE SOURCE	SAMPLE DATE	SAMPLE TAKEN	MBMG QW #	MBMG SITE #
16N 15W 01 BABAA		30-Jun-78		4199	70.	4,129	6	54.	13.	4,186	15	DOMESTIC	WELL	22-Feb-94	Y			
16N 15W 01 BACAA				4188	73.	4,115	6	18.1	18.1	4,170		DOMESTIC	WELL	29-Sep-93	Y			
16N 15W 01 BBAAA		6-May-86	Y	4199	112.	4,087	6	91.	80.	4,119	25	DOMESTIC	WELL	21-Jun-94	Y			M:72490
16N 15W 01 BBACB		06-Oct-79		4191	103.	4,088		95.	35.	4,156	20	DOMESTIC	WELL	26-Apr-94	Y			
16N 15W 01 BBBCA		28-May-85	Y	4191	100.	4,091	6	55.	45.	4,146	15	DOMESTIC	WELL	21-Jun-94	Y			M:72487
16N 15W 01 BBBCB				4188	81.	4,107	6		26.2	4,162		DOMESTIC	WELL	26-Apr-94	Y			
16N 15W 01 BBCAC		15-Jul-81	Y	4186	92.	4,094	6	85.	29.	4,157	30	DOMESTIC	WELL	21-Jun-94	Y			M:72486
16N 15W 01 BBCCA		16-May-78		4179	100.	4,079	6	30.	20.	4,159	7	DOMESTIC	WELL	8-Nov-93	Y			
16N 15W 01 BCAAD		1990	Y	4173	95.	4,078	6	80.	23.5	4,149	20	DOMESTIC	WELL	21-Jun-94	Y			M:24247
16N 15W 01 BCADA				4171			6					DOMESTIC	WELL	22-Feb-94	Y			
16N 15W 01 BCCBA		23-Mar-83	Y	4163	119.	4,044	6	70.	14.	4,149	40	DOMESTIC	WELL	21-Jun-94	Y			M:72488
16N 15W 01 BDCCB		16-Sep-80	Y	4160	85.	4,075	6	27.	15.	4,145	20	DOMESTIC	WELL	21-Jun-94	Y			M:72460
16N 15W 01 BDCCD				4154	90.	4,064	6					DOMESTIC	WELL	26-Apr-94	Y			
16N 15W 01 CABCD		19-Sep-72		4150	91.	4,059	6	60.			18	DOMESTIC	WELL	29-Mar-94	Y			
16N 15W 01 CACCA		08-Sep-83		4144	65.	4,079	6	55.	15.	4,129	5	DOMESTIC	WELL	26-Apr-94	Y			
16N 15W 01 CBAAB		04-May-84		4160	88.	4,072	6	84.	15.	4,145	5	DOMESTIC	WELL	29-Mar-94	Y			M:72467
16N 15W 01 CBABC		01-Jul-87	Y	4155	115.	4,040	6	32.	20.	4,135	30	DOMESTIC	WELL	29-Mar-94	Y			
16N 15W 01 CCADB		02-May-86		4136	160.	3,976	6	101.	99.	4,037	5	DOMESTIC	WELL	24-Aug-93	Y			
16N 15W 01 CCBCC		24-Sep-73		4140	80.	4,060	6	73.	17.	4,123	7	DOMESTIC	WELL	21-Jun-94	Y			
16N 15W 01 CDBBD		18-Mar-92	Y	4135	148.	3,987	6		30.	4,105	8	DOMESTIC	WELL	21-Jun-94	Y			M:134901
16N 15W 01 CDBDB				4152	127.	4,025	6		48.1	4,104		DOMESTIC	WELL	21-Jun-94	Y			
16N 15W 01 CDCCA		1992	Y	4122	125.	3,997	6		37.	4,085	5	DOMESTIC	WELL	21-Jun-94	Y			M:131040
16N 15W 02 01					129.			55.	18.		45		WELL					M:132348
16N 15W 02 01					82.			50.	26.		100		WELL					M:129445
16N 15W 02 01					65.			80.	26.		75		WELL					M:133949
16N 15W 02 A					88.			90.	24.		12		WELL					M:72504
16N 15W 02 A					94.			36.	23.		15		WELL					M:72506
16N 15W 02 A					90.			36.	25.		15		WELL					M:72505
16N 15W 02 A 01					100.			49.	30.		6.5		WELL					M:144803
16N 15W 02 AA					120.			170.	40.		20		WELL					M:72507
16N 15W 02 AA 01					260.			33.	170.		5		WELL					M:143759
16N 15W 02 AA 01					98.5			33.	33.		8		WELL					M:153293
16N 15W 02 AAACB	29-Oct-97	Early 60s	Y	4195	131.	4,064	6		22.	4,173	11	DOMESTIC	WELL	29-Oct-97	Y		98Q0543	M:163397
16N 15W 02 AABBA	28-Oct-97		Y	4195	88.	4,107	6	31.5	22.1	4,173	8	DOMESTIC	WELL	28-Oct-97	Y		98Q0546	

Seeley Lake ground-water inventory data

LOCATION	DATE INVENTORIED	DATE DRILLED	PUMP?	SURFACE ELEVATION (ft)	TOTAL DEPTH (ft)	BOTTOM ELEVATION (ft)	CASING DIAMETER (in)	PUMPING WATER LEVEL (ft)	STATIC WATER LEVEL (ft)	STATIC WATER LEVEL ELEVATION (ft)	PUMPING RATE, Q (gpm)	WATER USE	SAMPLE SOURCE	SAMPLE DATE	SAMPLE TAKEN	MBMG QW #	MBMG SITE #
16N 15W 02 AADDD		27-Aug-85		4185	90.	4,095	6	36.	25.	4,160	15	DOMESTIC	WELL	21-Jun-94	Y		
16N 15W 02 ABCAC	22-Jul-97	1994	Y	4195	245.	3,950	6				5.77	DOMESTIC	WELL	22-Jul-97	Y	98Q0064	
16N 15W 02 ABCAC	19-Jun-96	1994	Y	4195	245.	3,950	6		90.9	4,104	2.1	DOMESTIC	WELL		N		
16N 15W 02 ABCAC	19-Jun-96	1994	Y	4195	245.	3,950	6		90.9	4,104	2.1	DOMESTIC	WELL		N		
16N 15W 02 B 01					32.5				7.		1		WELL				M:126958
16N 15W 02 BB 01					200.				23.		12		WELL				M:143150
16N 15W 02 BCBBB	6-Dec-96		N	4095	650R	3,445R	6	48R	3.6	4,091	5	DOMESTIC	WELL		N		M:72508
16N 15W 02 BCBD 01				4080	375.	3,705			120.	3,960	7.5		WELL				M:153294
16N 15W 02 BCCBC		1993		4071	48.	4,023	2					MONITORING	WELL	21-Jun-94	Y		
16N 15W 02 CAD 01				4260	170.	4,090			112.	4,148	2		WELL				M:153295
16N 15W 03					68.			11.	56.		16		WELL				M:72511
16N 15W 03					451.				400.		300		WELL				M:72510
16N 15W 03									3.		25		WELL				M:72509
16N 15W 03 01					94.				38.		15		WELL				M:132349
16N 15W 03 01					180.				35.		6		WELL				M:138619
16N 15W 03 AAAAB 01	20-May-97		Y	4090							0.25	DOMESTIC	WELL	20-May-97	Y	97Q0796	M:132350
16N 15W 03 AAAAB 01	3-Dec-96		Y	4090	240R	3,850R			90R	4,000R	.25R	DOMESTIC	WELL		N		M:132350
16N 15W 03 ABCBA	4-Dec-96	1947	Y	4018	18.2	4,000	18		16.4	4,002		UNUSED	WELL		N		
16N 15W 03 ABCBC	16-Oct-97		N	4030	46.9	3,978	2		33.8	3,991		MONITORING	WELL	15-Oct-97	Y	98Q0518	M:163400
16N 15W 03 ABCBC	16-Oct-97		N	4030	46.9	3,978	2		33.8	3,991		MONITORING	WELL	15-Oct-97	Y	98Q0518	M:163400
16N 15W 03 AD 01					180.								WELL				M:151032
16N 15W 03 ADBDD	19-Jun-96		N	4050	93.	3,957	6		37.4	4,013		INOPERABLE	WELL		N		
16N 15W 03 ADDBB	14-Nov-96		Y	4060	142R	3,918R	6		60R	4,000R	5	DOMESTIC	WELL	15-Oct-97	Y	98Q0515	M:72513
16N 15W 03 BCDBB	19-Aug-96		N	4001			4		3.3	3,998		UNUSED	HOLE		N		
16N 15W 03 BCDBC	19-Aug-96		N	4002			4		3.8	3,998		UNUSED	HOLE		N		
16N 15W 03 CBBAA	19-Aug-96		N	4003			4		4.3	3,999		UNUSED	HOLE		N		
16N 15W 03 CBBAD	19-Aug-96		N	4004			4		4.1	4,000		UNUSED	HOLE		N		
16N 15W 03 CDAAD	3-Dec-96	1953	Y	4025	238R	3,787R	6		27.9	3,997	150R	INDUSTRIAL	WELL		N		M:72517
16N 15W 03 CDCBDD	18-Jun-96	1952	N	4013	12.	4,001	24		10.5	4,003		UNUSED	WELL		N		
16N 15W 03 CDCCAB	20-May-97	1957?	N	4018	24.	3,994	6	22.	18.	4,000	0.4	UNUSED	WELL	20-May-97	Y	97Q0792	
16N 15W 03 CDCCAB	22-Jul-97	1957?	N	4018			6					UNUSED	WELL	22-Jul-97	Y		
16N 15W 03 CDCCAB	18-Jun-96	1957?	N	4018	20.	3,998	6		19.	3,999		UNUSED	WELL		N		
16N 15W 03 D					68.				56.		16		WELL				M:72516

Seeley Lake ground-water inventory data

LOCATION	DATE INVENTORIED	DATE DRILLED	PUMP?	SURFACE ELEVATION (ft)	TOTAL DEPTH (ft)	BOTTOM ELEVATION (ft)	CASING DIAMETER (in)	PUMPING WATER LEVEL (ft)	STATIC WATER LEVEL (ft)	STATIC WATER LEVEL (ft)	PUMPING RATE, Q (gpm)	WATER USE	SAMPLE SOURCE	SAMPLE DATE	SAMPLE TAKEN	MBMG QW #	MBMG SITE #
16N 15W 03 DABBBB	22-Jul-97	1995	N	4045	57.	3,988	2		46.9	3,998		MONITORING	WELL	22-Jul-97	Y	98Q0063	M:161807
16N 15W 03 DABBBB	18-Jun-96	1995	N	4045	51.	3,994	2		48.8	3,996		MONITORING	WELL		N		M:161807
16N 15W 03 DABBBB	19-Aug-96	1995	N	4045			2		51.4	3,994		MONITORING	WELL		N		M:161807
16N 15W 03 DADBAA	20-May-97	1985	Y	4060							12	DOM/IRR	WELL	20-May-97	Y	97Q0795	M:72514
16N 15W 03 DADBAA	19-Jun-96	1985	Y	4060	120.	3,940	6	62.7	62.7	3,997	12	DOM/IRR	WELL		N		M:72514
16N 15W 03 DBCCA 01	3-Dec-96	1990	Y	4025	200R	3,825R	6	50R	33R	3,992R	20R	INDUSTRIAL	WELL		N		M:120515
16N 15W 03 DBCDB 01	3-Dec-96	1990	Y	4025	60R	3,965R	6	50R	33R	3,992R	17R	INDUSTRIAL	WELL		N		M:120514
16N 15W 03 DDABCA	20-May-97	~1986	Y	4050							9	DOM/COMM	WELL	20-May-97	Y	97Q0797	M:72515
16N 15W 03 DDABCA	3-Dec-96	~1986	Y	4050	100R	3,950R	6	60R	54.5	3,996	12.5	DOM/COMM	WELL		N		M:72515
16N 15W 04 01					110.			60.	- 2.3		8		WELL				M:146741
16N 15W 04 01					120.						15		WELL				M:151160
16N 15W 04 01					110.			60.	- 2.3		8		WELL				M:146742
16N 15W 04 A					135.			23.	10.		20		WELL				M:72518
16N 15W 04 A 01					188.				20.				WELL				M:120516
16N 15W 04 AA 01					181.				5.		4		WELL				M:143760
16N 15W 04 D 01					110.						15		WELL				M:152173
16N 15W 10					25.				18.		6		WELL				M:72520
16N 15W 10 01					125.			72.	60.		6		WELL				M:131041
16N 15W 10 A 01					62.				32.		30		WELL				M:124691
16N 15W 10 AC 01					90.				15.		20		WELL				M:151055
16N 15W 10 B					7.								WELL				M:72521
16N 15W 10 B					7.								WELL				M:72522
16N 15W 10 B 01					102.				18.		20		WELL				M:24247
16N 15W 10 BA					151.			20.	16.		30		WELL				M:72523
16N 15W 10 BAADBA 01	20-May-97	1995	Y	4022				17.2	16.7	4,005	12	DOMESTIC	WELL	20-May-97	Y	97Q0807	M:138620
16N 15W 10 BAADBA 01	8-Aug-96	1995	Y	4022			6		15.8	4,006	12R	DOMESTIC	WELL		N		M:138620
16N 15W 10 BAADBA 01	17-Jun-96	1995	Y	4022	60.	3,962	6	14.5	14.5	4,008	12R	DOMESTIC	WELL		N		M:138620
16N 15W 10 BC					10.			5.	5.		25		WELL				M:72524
16N 15W 10 CA 01				4006	15.			8.	10.		60		WELL				M:72525
16N 15W 10 DB 01					160.				7.		4		WELL				M:143761
16N 15W 11					330.			150.	115.		12		WELL				M:72526
16N 15W 11					201.			140.	55.		6		WELL				M:72527
16N 15W 11					250.				70.		20		WELL				M:72536

Seeley Lake ground-water inventory data

LOCATION	DATE INVENTORIED	DATE DRILLED	PUMP?	SURFACE ELEVATION (ft)	TOTAL DEPTH (ft)	BOTTOM ELEVATION (ft)	CASING DIAMETER (in)	PUMPING WATER LEVEL (ft)	STATIC WATER LEVEL (ft)	STATIC WATER LEVEL ELEVATION (ft)	PUMPING RATE, Q (gpm)	WATER USE	SAMPLE SOURCE	SAMPLE DATE	SAMPLE TAKEN	MBMG QW #	MBMG SITE #
16N 15W 11					70.			31.	20.		20		WELL				M:72534
16N 15W 11					170.			120.	100.		15		WELL				M:72532
16N 15W 11					160.			140.	51.		7		WELL				M:72528
16N 15W 11					140.			120.	30.		25		WELL				M:72533
16N 15W 11					60.			25.	10.		25		WELL				M:72530
16N 15W 11					60.			25.	20.		25		WELL				M:72529
16N 15W 11					130.			60.	40.		20		WELL				M:72535
16N 15W 11					100.			60.	40.		20		WELL				M:72531
16N 15W 11 01					60.				25.		120		WELL				M:144804
16N 15W 11 01					180.				.		0		WELL				M:131042
16N 15W 11 01					220.			166.	148.		10		WELL				M:123646
16N 15W 11 01					265.			265.	100.		2		WELL				M:124692
16N 15W 11 AA 01					140.				57.		15		WELL				M:143762
16N 15W 11 AA 01					140.				50.		12		WELL				M:143151
16N 15W 11 ABB 01				4160	115.	4,045			20.	4,140	35		WELL				M:132928
16N 15W 11 ABCBD	28-Oct-97	1993	Y	4105			6	91.	76.2	4,029	2.1	DOMESTIC	WELL	28-Oct-97	Y	98Q0545	
16N 15W 11 ABCBD	4-Dec-96	1993	Y	4105			6	91.	76.2	4,029	2.1	DOMESTIC	WELL		N		
16N 15W 11 ACABB	29-Oct-97	1996	Y	4080	132.	3,948	6	99.6	98.6	3,981	6	DOMESTIC	WELL	29-Oct-97	Y	98Q0547	
16N 15W 11 ACCCA	28-Oct-97		Y	4025			6		47.7	3,977		DOMESTIC	WELL	28-Oct-97	Y	98Q0544	
16N 15W 11 ACCCA	4-Dec-96		Y	4025			6		47.7	3,977		DOMESTIC	WELL		N		
16N 15W 11 ACD 01				4040	100.	3,940			60.	3,980	30		WELL				M:143763
16N 15W 11 AD 01					100.				33.5		60		WELL				M:151077
16N 15W 11 ADCDD	14-Nov-96			4065			6		18.9	4,046		DOMESTIC	WELL		N		
16N 15W 11 ADCDD	14-Nov-96			4065			6		18.9	4,046		DOMESTIC	WELL		N		
16N 15W 11 BC					200.			22.	10.		60		WELL				M:72537
16N 15W 11 BC 01					180.				29.		3		WELL				M:155590
16N 15W 11 BDD 01				4000	120.	3,880			44.	3,956	50		WELL				M:152174
16N 15W 11 CAD 01					60.				30.		30		WELL				M:143764
16N 15W 11 CB 01					98.				87.		10		WELL				M:155591
16N 15W 11 CC 01					120.				6.		9		WELL				M:151041
16N 15W 11 D					61.			60.	7.		100		WELL				M:72538
16N 15W 11 DA 01					178.				80.		4		WELL				M:151040
16N 15W 11 DA 01					120.				83.		15		WELL				M:140824

Seeley Lake ground-water inventory data

LOCATION	DATE INVENTORIED	DATE DRILLED	PUMP?	SURFACE ELEVATION (ft)	TOTAL DEPTH (ft)	BOTTOM ELEVATION (ft)	CASING DIAMETER (in)	PUMPING WATER LEVEL (ft)	STATIC WATER LEVEL (ft)	STATIC WATER LEVEL ELEVATION (ft)	PUMPING RATE, Q (gpm)	WATER USE	SAMPLE SOURCE	SAMPLE DATE	SAMPLE TAKEN	MBMG QW #	MBMG SITE #
16N 15W 11 DA 01					90.				55.		30		WELL				M:127565
16N 15W 11 DA 02					120.				83.		20		WELL				M:140826
16N 15W 11 DC 01					100.				45.		60		WELL				M:144805
16N 15W 11 DD					78.			60.	25.		25		WELL				M:72539
16N 15W 12					253.			122.	111.		25		WELL				M:72540
16N 15W 12					109.			87.	75.		30		WELL				M:72541
16N 15W 12 01					120.				73.		6		WELL				M:136563
16N 15W 12 01					40.				16.		3		WELL				M:131043
16N 15W 12 01					50.				30.		30		WELL				M:136564
16N 15W 12 A					96.				46.		30		WELL				M:72543
16N 15W 12 A					151.			131.	43.		15		WELL				M:72542
16N 15W 12 AA					160.						15		WELL				M:72545
16N 15W 12 AA					360.			360.			1		WELL				M:72544
16N 15W 12 ABC 01				4195	220.	3,975			150.	4,045	3		WELL				M:155592
16N 15W 12 AD					303.			53.	50.2		12		WELL				M:154115
16N 15W 12 AD					138.			65.	20.		20		WELL				M:72546
16N 15W 12 AD 01					295.			200.			2		WELL				M:149749
16N 15W 12 B 01					194.				30.		3		WELL				M:126273
16N 15W 12 BB					89.			40.	18.		25		WELL				M:72547
16N 15W 12 BBBAC	4-Dec-96		Y	4107	55R	4,052R	6		20.	4,087		UNUSED	WELL		N		
16N 15W 12 BBBB	15-Oct-97	1983	Y	4115	86R	4,029R	6		27.3	4,088		DOMESTIC	WELL	15-Oct-97	Y	98Q0517	
16N 15W 12 BBBBD	4-Dec-96	1988	Y	4108	155R	3,853R	6		33.4	4,075	15	DOMESTIC	WELL	15-Oct-97	Y	98Q0516	
16N 15W 12 BC 01					200.				80.		4		WELL				M:151038
16N 15W 12 BDB				4120	340.	3,780		180.	105.	4,015	3		WELL				M:72548
16N 15W 12 C					228.			200.	58.		20		WELL				M:72549
16N 15W 12 CAB 01					300.				150.		5		WELL				M:132921
16N 15W 12 CB 01					220.				60.		2		WELL				M:155593
16N 15W 12 CC 01					160.			150.	30.		10		WELL				M:134905
16N 15W 12 DB 01					460.				56.		2.5		WELL				M:153296
17N 15W 33 BADAAB	18-Jun-96		Y	4032	135.	3,897	7	42.	14.6	4,017	21	CAMPGROUND	WELL		N		M:73039
17N 15W 33 BD					227.				35.		20		WELL				M:73040
17N 15W 33 BDAAB		1962		4017			3				11.5	CAMPGROUND	WELL	21-Jun-94	Y		
17N 15W 33 BDADA		1930		4002			3					CAMPGROUND	WELL	21-Jun-94	Y		

Seeley Lake ground-water inventory data

LOCATION	DATE INVENTORIED	DATE DRILLED	PUMP?	SURFACE ELEVATION (ft)	TOTAL DEPTH (ft)	BOTTOM ELEVATION (ft)	CASING DIAMETER (in)	PUMPING WATER LEVEL (ft)	STATIC WATER LEVEL (ft)	STATIC WATER LEVEL ELEVATION (ft)	PUMPING RATE, Q (gpm)	WATER USE	SAMPLE SOURCE	SAMPLE DATE	SAMPLE TAKEN	MBMG QW #	MBMG SITE #
17N 15W 33 BDDDA		1966		4002			3				20	CAMPGROUND	WELL	21-Jun-94	Y		
17N 15W 33 DC				4000	280.			72.	8.		20		WELL			M:73041	
17N 15W 34 DD											9		WELL			M:73042	
17N 15W 36 BBDBBD	19-Jun-96	1988?	Y	4245	8.	4,237	24					RECHARGE	WELL		N		

Appendix D

Ground-water quality data

Seeley Lake ground-water data - parameters

LOCATION	SAMPLE DATE	SAMPLE SOURCE	TDS, CALCULATED (mg/L)	TDS, SUM OF DISSOLVED CONSTITUENTS (mg/L)	FIELD SC (µmho/cm)	LAB SC (µmho/cm)	FIELD pH	LAB pH	HARDNESS AS CaCO3 (mg/L)	ALKALINITY AS CaCO3 (mg/L)	RYZNAR STABILITY INDEX	LANGELIER SATURATION INDEX	SODIUM ADSORPTION RATIO, SAR	AIR TEMPERATURE (deg C)	WATER TEMPERATURE (deg C)
16N 14W 06 AAAA		WELL			413		7.9								7.
16N 14W 06 BBBCA		WELL			390		6.9								6.7
16N 14W 07 BDDDB		WELL			356		7.								7.4
16N 14W 07 CABD		WELL			390		7.4								8.5
16N 14W 07 CCBB		WELL			262		7.2								7.
16N 15W 01 BABAA	8-Nov-93	WELL	219.2	341.7											
16N 15W 01 BABAA	25-Jan-94	WELL	222.4	336.8											
16N 15W 01 BABAA	22-Feb-94	WELL	211.8	318.2											
16N 15W 01 BACAA	1-Sep-93	WELL	208.9	320.3						180.					
16N 15W 01 BACAA	29-Sep-93	WELL	211.9	330.1											
16N 15W 01 BBAAA	24-Aug-93	WELL	21.9	21.9											
16N 15W 01 BBAAA	29-Sep-93	WELL	204.2	317.4											
16N 15W 01 BBAAA	29-Mar-94	WELL	230.8	348.4											
16N 15W 01 BBAAA	21-Jun-94	WELL	243.6	357.4											
16N 15W 01 BBACB	10-Aug-93	WELL	93.1	93.1											
16N 15W 01 BBACB	8-Nov-93	WELL	190.4	289.4											
16N 15W 01 BBACB	25-Jan-94	WELL	207.7	317.8											
16N 15W 01 BBACB	22-Feb-94	WELL	196.2	296.4											
16N 15W 01 BBACB	29-Mar-94	WELL	200.6	309.5											
16N 15W 01 BBACB	26-Apr-94	WELL	190.5	288.2											
16N 15W 01 BBBCA	24-Aug-93	WELL	76.8	76.8											
16N 15W 01 BBBCA	29-Sep-93	WELL	149.9	227.3											
16N 15W 01 BBBCA	21-Jun-94	WELL	185.6	273.4											
16N 15W 01 BBBCB	24-Aug-93	WELL	84.6	84.6											
16N 15W 01 BBBCB	25-Jan-94	WELL	190.9	292.3											
16N 15W 01 BBBCB	22-Feb-94	WELL	168.7	250.3											
16N 15W 01 BBBCB	29-Mar-94	WELL	175.1	260.4											
16N 15W 01 BBBCB	26-Apr-94	WELL	167.8	252.											
16N 15W 01 BBCAC	24-Aug-93	WELL	69.9	69.9											
16N 15W 01 BBCAC	29-Sep-93	WELL	138.6	211.6											
16N 15W 01 BBCAC	8-Nov-93	WELL	143.6	220.3											
16N 15W 01 BBCAC	25-Jan-94	WELL	156.7	237.1											
16N 15W 01 BBCAC	22-Feb-94	WELL	145.	215.5											
16N 15W 01 BBCAC	29-Mar-94	WELL	144.7	221.4											
16N 15W 01 BBCAC	26-Apr-94	WELL	142.2	217.7											
16N 15W 01 BBCAC	21-Jun-94	WELL	142.	210.											
16N 15W 01 BBCCA	10-Aug-93	WELL	87.4	87.4											
16N 15W 01 BBCCA	29-Sep-93	WELL	184.4	283.4											
16N 15W 01 BBCCA	8-Nov-93	WELL	175.9	270.5											
16N 15W 01 BCAAD	24-Aug-93	WELL	78.8	78.8											
16N 15W 01 BCAAD	29-Sep-93	WELL	171.8	264.6											
16N 15W 01 BCAAD	25-Jan-94	WELL	168.2	257.3											
16N 15W 01 BCAAD	29-Mar-94	WELL	164.7	253.7											
16N 15W 01 BCAAD	26-Apr-94	WELL	165.1	253.											
16N 15W 01 BCAAD	21-Jun-94	WELL	202.5	304.											
16N 15W 01 BCADA	24-Aug-93	WELL	88.2	88.2											
16N 15W 01 BCADA	8-Nov-93	WELL	176.2	269.											
16N 15W 01 BCADA	25-Jan-94	WELL	186.6	283.2											

Seeley Lake ground-water data - parameters

LOCATION	SAMPLE DATE	SAMPLE SOURCE	TDS, CALCULATED (mg/L)	TDS, SUM OF DISSOLVED CONSTITUENTS (mg/L)	FIELD SC (µmho/cm)	LAB SC (µmho/cm)	FIELD pH	LAB pH	HARDNESS AS CaCO3 (mg/L)	ALKALINITY AS CaCO3 (mg/L)	RYZNAR STABILITY INDEX	LANGELIER SATURATION INDEX	SODIUM ADSORPTION RATIO, SAR	AIR TEMPERATURE (deg C)	WATER TEMPERATURE (deg C)
16N 15W 01 BCADA	22-Feb-94	WELL	165.5	242.2											
16N 15W 01 BCCBA	24-Aug-93	WELL	76.	76.											
16N 15W 01 BCCBA	8-Nov-93	WELL	154.9	237.8											
16N 15W 01 BCCBA	25-Jan-94	WELL	168.	257.1											
16N 15W 01 BCCBA	22-Feb-94	WELL	155.6	234.1											
16N 15W 01 BCCBA	29-Mar-94	WELL	148.3	221.3											
16N 15W 01 BCCBA	26-Apr-94	WELL	146.7	228.4											
16N 15W 01 BCCBA	21-Jun-94	WELL	171.9	259.7											
16N 15W 01 BDCCB	25-Jan-94	WELL	218.	334.3											
16N 15W 01 BDCCB	22-Feb-94	WELL	204.5	310.9											
16N 15W 01 BDCCB	29-Mar-94	WELL	111.	222.4											
16N 15W 01 BDCCB	21-Jun-94	WELL	217.2	326.											
16N 15W 01 BDCCD	1-Sep-93	WELL	198.6	304.4											
16N 15W 01 BDCCD	29-Sep-93	WELL	199.8	309.3											
16N 15W 01 BDCCD	8-Nov-93	WELL	192.7	297.9											
16N 15W 01 BDCCD	22-Feb-94	WELL	200.9	304.8											
16N 15W 01 BDCCD	26-Apr-94	WELL	194.9	301.3											
16N 15W 01 CABCD	1-Sep-93	WELL	208.1	320.7											
16N 15W 01 CABCD	25-Jan-94	WELL	217.1	335.3											
16N 15W 01 CABCD	29-Mar-94	WELL	217.	333.3											
16N 15W 01 CACCA	1-Sep-93	WELL	212.9	327.4											
16N 15W 01 CACCA	29-Sep-93	WELL	211.8	327.5											
16N 15W 01 CACCA	8-Nov-93	WELL	208.	323.1											
16N 15W 01 CACCA	26-Apr-94	WELL	183.4	286.1											
16N 15W 01 CBAAB	1-Sep-93	WELL	177.5	270.3											
16N 15W 01 CBAAB	29-Mar-94	WELL	180.9	274.9											
16N 15W 01 CBABC	24-Aug-93	WELL	84.6	84.6											
16N 15W 01 CBABC	8-Nov-93	WELL	174.8	270.											
16N 15W 01 CBABC	25-Jan-94	WELL	184.3	283.2											
16N 15W 01 CBABC	22-Feb-94	WELL	173.8	262.2											
16N 15W 01 CBABC	29-Mar-94	WELL	182.3	282.5											
16N 15W 01 CCADB	24-Aug-93	WELL	80.6	80.6											
16N 15W 01 CCBCC	24-Aug-93	WELL	89.1	89.1											
16N 15W 01 CCBCC	29-Sep-93	WELL	174.6	264.3											
16N 15W 01 CCBCC	8-Nov-93	WELL	172.7	261.1											
16N 15W 01 CCBCC	25-Jan-94	WELL	168.8	246.7											
16N 15W 01 CCBCC	22-Feb-94	WELL	170.7	252.3											
16N 15W 01 CCBCC	29-Mar-94	WELL	145.3	206.5											
16N 15W 01 CCBCC	26-Apr-94	WELL	135.9	198.3											
16N 15W 01 CCBCC	21-Jun-94	WELL	163.3	235.1											
16N 15W 01 CDBBD	1-Sep-93	WELL	204.9	319.3											
16N 15W 01 CDBBD	25-Jan-94	WELL	204.3	315.6											
16N 15W 01 CDBBD	22-Feb-94	WELL	90.1	180.4											
16N 15W 01 CDBBD	29-Mar-94	WELL	105.6	212.											
16N 15W 01 CDBBD	26-Apr-94	WELL	182.3	281.2											
16N 15W 01 CDBBD	21-Jun-94	WELL	217.2	327.3											
16N 15W 01 CDBDB	24-Aug-93	WELL	96.	96.											

Seeley Lake ground-water data - parameters

LOCATION	SAMPLE DATE	SAMPLE SOURCE	TDS, CALCULATED (mg/L)	TDS, SUM OF DISSOLVED CONSTITUENTS (mg/L)	FIELD SC (µmho/cm)	LAB SC (µmho/cm)	FIELD pH	LAB pH	HARDNESS AS CaCO3 (mg/L)	ALKALINITY AS CaCO3 (mg/L)	RYZNAR STABILITY INDEX	LANGELIER SATURATION INDEX	SODIUM ADSORPTION RATIO, SAR	AIR TEMPERATURE (deg C)	WATER TEMPERATURE (deg C)
16N 15W 01 CDBDB	29-Sep-93	WELL	180.8	271.7											
16N 15W 01 CDBDB	8-Nov-93	WELL	187.7	286.6											
16N 15W 01 CDBDB	8-Nov-93	WELL	200.9	303.6											
16N 15W 01 CDBDB	22-Feb-94	WELL	186.3	279.1											
16N 15W 01 CDBDB	29-Mar-94	WELL	189.	288.6											
16N 15W 01 CDBDB	26-Apr-94	WELL	172.4	256.6											
16N 15W 01 CDBDB	21-Jun-94	WELL	199.9	298.8											
16N 15W 01 CDCCA	1-Sep-93	WELL	209.8	324.3											
16N 15W 01 CDCCA	29-Sep-93	WELL	198.5	303.6											
16N 15W 01 CDCCA	8-Nov-93	WELL	206.9	320.1											
16N 15W 01 CDCCA	25-Jan-94	WELL	215.1	330.1											
16N 15W 01 CDCCA	29-Mar-94	WELL	217.9	330.4											
16N 15W 01 CDCCA	26-Apr-94	WELL	205.2	316.5											
16N 15W 01 CDCCA	21-Jun-94	WELL	219.5	329.6											
16N 15W 02 AAACB	10-Aug-93	WELL	81.9	81.9											
16N 15W 02 AAACB	29-Sep-93	WELL	171.4	264.2											
16N 15W 02 AAACB	8-Nov-93	WELL	167.5	256.6											
16N 15W 02 AAACB	25-Jan-94	WELL	176.	268.8											
16N 15W 02 AAACB	29-Mar-94	WELL	177.6	270.4											
16N 15W 02 AAACB	26-Apr-94	WELL	175.9	267.4											
16N 15W 02 AAACB	21-Jun-94	WELL	178.7	269.											
16N 15W 02 AAACB	29-Oct-97	WELL	177.6	276.5	191	306	7.3	8.5	147.6	160.	6.9	.79	.23	7.	8.
16N 15W 02 AABBA	28-Oct-97	WELL	145.7	222.5	229	247	7.6	8.7	125.7	124.4	7.	.86	.15	6.	7.
16N 15W 02 AADDD	10-Aug-93	WELL	83.2	83.2											
16N 15W 02 AADDD	29-Sep-93	WELL	161.2	241.6											
16N 15W 02 AADDD	8-Nov-93	WELL	160.2	240.6											
16N 15W 02 AADDD	25-Jan-94	WELL	167.9	252.1											
16N 15W 02 AADDD	22-Feb-94	WELL	158.1	233.6											
16N 15W 02 AADDD	29-Mar-94	WELL	165.6	248.5											
16N 15W 02 AADDD	26-Apr-94	WELL	165.	247.9											
16N 15W 02 AADDD	21-Jun-94	WELL	168.	248.5											
16N 15W 02 ABCAC	22-Jul-97	WELL	158.1	250.	271	320	8.	7.7	140.9	148.5	8.	-.16	.22	17.	11.
16N 15W 02 BCCBBC	22-Feb-94	WELL	127.6	179.5											
16N 15W 02 BCCBBC	29-Mar-94	WELL	118.2	175.1											
16N 15W 02 BCCBBC	26-Apr-94	WELL	121.5	184.6											
16N 15W 02 BCCBBC	21-Jun-94	WELL	136.8	196.2											
16N 15W 03 AAAAB	20-May-97	WELL	153.9	244.	241	234	7.7	7.9	124.5	145.7	8.1	-.11	.38	12.	9.
16N 15W 03 ABDCBC	29-Mar-94	WELL	125.9	163.1											
16N 15W 03 ABDCBC	26-Apr-94	WELL	123.4	161.7											
16N 15W 03 ABDCBC	21-Jun-94	WELL	117.7	156.											
16N 15W 03 ABDCBC	15-Oct-97	WELL	143.8	188.7	219	230	6.4	8.2	92.9	72.7	8.5	-.13	.3		8.
16N 15W 03 ADDBB	15-Oct-97	WELL	147.7	219.9	251	263	7.6	8.1	125.	116.7	7.7	.23	.15		8.5
16N 15W 03 CDCCA	20-May-97	WELL	247.2	294.8	517	501	7.	6.5	227.7	76.9	9.1	-1.27	.4	15.	7.5
16N 15W 03 DABBBB	29-Mar-94	WELL	624.3	963.3											
16N 15W 03 DABBBB	26-Apr-94	WELL	435.8	677.1											
16N 15W 03 DABBBB	22-Jul-97	WELL	734.1	1,167.4	1155	1194	6.8	6.8	730.2	700.4	5.8	.47	.13	20.5	10.
16N 15W 03 DADBAA	20-May-97	WELL	577.2	887.2	955	893	7.	7.2	635.3	501.2	6.	.57	.1	23.	8.5

Seeley Lake ground-water data - parameters

LOCATION	SAMPLE DATE	SAMPLE SOURCE	TDS, CALCULATED (mg/L)	TDS, SUM OF DISSOLVED CONSTITUENTS (mg/L)	FIELD SC (µmho/cm)	LAB SC (µmho/cm)	FIELD pH	LAB pH	HARDNESS AS CaCO3 (mg/L)	ALKALINITY AS CaCO3 (mg/L)	RYZNAR STABILITY INDEX	LANGELIER SATURATION INDEX	SODIUM ADSORPTION RATIO, SAR	AIR TEMPERATURE (deg C)	WATER TEMPERATURE (deg C)
16N 15W 03 DDABCA	20-May-97	WELL	325.3	500.4	561	524	7.5	7.6	338.4	283.1	6.6	.52	.08	12.	8.5
16N 15W 10 BAADBA	20-May-97	WELL	150.8	211.3	285	261	7.2	7.3	128.5	97.8	8.6	-.67	.2	5.	6.5
16N 15W 11 ABCBD	28-Oct-97	WELL	212.9	325.4	349	369	7.5	8.7	77.3	182.1	7.2	.78	2.27	6.	8.
16N 15W 11 ACABB	29-Oct-97	WELL	151.3	225.9	155	254	7.	8.7	105.8	120.8	7.1	.78	.5	7.	7.
16N 15W 11 ACCCA	28-Oct-97	WELL	133.	208.3	219	240	7.2	8.2	118.1	121.7	7.6	.33	.13	6.	7.
16N 15W 12 BBBB	15-Oct-97	WELL	184.6	277.9	288	307	7.9	8.8	156.7	172.9	6.4	1.2	.21		8.
16N 15W 12 BBBBD	15-Oct-97	WELL	179.5	275.7	285	301	7.7	8.7	152.9	167.2	6.6	1.03	.21		8.
16N 15W 14 AABB		WELL			301		7.8								7.8
17N 15W 33 BDAAB	21-Jun-94	WELL	135.1	135.1											
17N 15W 33 BDADA	21-Jun-94	WELL	236.9	311.1											
17N 15W 33 BDDDA	21-Jun-94	WELL	216.7	305.8											

Seeley Lake ground-water data - major elements

LOCATION	SAMPLE DATE	SAMPLE SOURCE	MIBMG QW #	Ca (mg/L)	Mg (mg/L)	Na (mg/L)	K (mg/L)	Fe (mg/L)	Mn (mg/L)	SiO ₂ (mg/L)	HCO ₃ (mg/L)	CO ₃ (mg/L)	Cl (mg/L)	SO ₄ (mg/L)	NO ₃ as N (mg/L)	F (mg/L)	PO ₄ as P (mg/L)
16N 15W 01 BABAA	8-Nov-93	WELL		59.7	14.6	5.5	1.8	<0.03	<0.005	16.28	241.4		.9	1.4	.1		<0.5
16N 15W 01 BABAA	25-Jan-94	WELL		66.	15.8	6.1	3.7	<0.03	<0.005	16.73	225.6		1.3	1.5	.1		<0.5
16N 15W 01 BABAA	22-Feb-94	WELL		65.5	15.9	5.7	1.9	<0.03	<0.005	16.95	209.7		.9	1.5	.1		<0.5
16N 15W 01 BACAA	1-Sep-93	WELL		60.4	14.3	6.4	<1.5	<0.03	<0.005	17.20	219.5		.9	1.4	.1		<0.5
16N 15W 01 BACAA	29-Sep-93	WELL		57.5	13.6	6.2	<1.5	<0.03	<0.005	17.18	232.9		1.1	1.4	.1		<0.5
16N 15W 01 BBAAA	24-Aug-93	WELL		1.	<0.1	NA	1.5	<0.03	<0.005	16.28			1.3	1.7	.1		<0.5
16N 15W 01 BBAAA	29-Sep-93	WELL		54.3	12.7	6.7	<1.5	<0.03	<0.005	16.73	223.1		1.	1.7	1.1		<0.5
16N 15W 01 BBAAA	29-Mar-94	WELL		.3	.1	94.2	1.7	<0.03	<0.005	17.62	231.7		1.	1.7	.1		<0.5
16N 15W 01 BBAAA	21-Jun-94	WELL		.1	<0.1	113.	<1.5	<0.03	<0.005	16.95	224.3		.9	2.	.1		<0.5
16N 15W 01 BBACB	10-Aug-93	WELL		54.2	11.2	7.4	<1.5	<0.03	<0.005	17.18			.8	2.3	<0.1		<0.5
16N 15W 01 BBACB	8-Nov-93	WELL		53.	11.3	7.1	2.	<0.03	<0.005	17.85	195.1		.7	2.1	.2		<0.5
16N 15W 01 BBACB	25-Jan-94	WELL		56.5	11.7	7.4	3.8	<0.03	<0.005	18.07	217.0		1.1	2.	.2		<0.5
16N 15W 01 BBACB	22-Feb-94	WELL		56.8	11.9	7.3	1.9	<0.03	<0.005	18.07	197.5		.8	2.	.1		<0.5
16N 15W 01 BBACB	29-Mar-94	WELL		53.2	11.6	7.3	1.8	<0.03	<0.005	17.85	214.6		.9	2.	.2		<0.5
16N 15W 01 BBACB	26-Apr-94	WELL		55.7	11.6	7.2	<1.5	<0.03	<0.005	18.07	192.6		.8	1.9	.2		<0.5
16N 15W 01 BBBCA	24-Aug-93	WELL		40.2	9.1	5.3	2.2	<0.03	<0.005	16.06			1.	2.6	.3		<0.5
16N 15W 01 BBBCA	29-Sep-93	WELL		39.1	8.9	4.6	1.6	<0.03	<0.005	16.73	152.4		1.2	2.4	.3		<0.5
16N 15W 01 BBBCA	21-Jun-94	WELL		51.6	11.9	7.	<1.5	<0.03	<0.005	17.18	173.1		.9	11.5	.2		<0.5
16N 15W 01 BBBCB	24-Aug-93	WELL		49.8	10.6	3.1	2.1	<0.03	<0.005	15.84			1.3	1.4	.4		<0.5
16N 15W 01 BBBCB	25-Jan-94	WELL		52.7	11.2	3.4	4.	<0.03	<0.005	16.73	200.0		1.6	1.5	.4		<0.5
16N 15W 01 BBBCB	22-Feb-94	WELL		52.5	11.2	3.	2.	<0.03	<0.005	16.95	160.9		1.5	1.5	.4		<0.5
16N 15W 01 BBBCB	29-Mar-94	WELL		53.7	11.7	3.1	2.3	<0.03	<0.005	17.40	168.3		1.5	1.5	.5		<0.5
16N 15W 01 BBBCB	26-Apr-94	WELL		51.3	11.1	3.1	<1.5	<0.03	<0.005	16.73	165.8		1.4	1.5	.5		<0.5
16N 15W 01 BBCAC	24-Aug-93	WELL		36.4	8.5	4.3	2.	<0.03	<0.005	15.62			.8	1.9	.3		<0.5
16N 15W 01 BBCAC	29-Sep-93	WELL		35.4	8.7	4.4	<1.5	<0.03	<0.005	16.06	143.9		.9	1.9	.3		<0.5
16N 15W 01 BBCAC	8-Nov-93	WELL		35.4	8.5	4.3	2.	<0.03	<0.005	16.06	151.2		.7	1.9	.2		<0.5
16N 15W 01 BBCAC	25-Jan-94	WELL		39.5	9.3	5.	4.2	<0.03	<0.005	17.18	158.5		1.1	2.1	.2		<0.5
16N 15W 01 BBCAC	22-Feb-94	WELL		39.7	9.5	4.8	2.2	<0.03	<0.005	17.40	139.0		.7	2.	.2		<0.5
16N 15W 01 BBCAC	29-Mar-94	WELL		35.6	8.8	4.4	2.1	<0.03	<0.005	16.28	151.2		.9	1.9	.2		<0.5
16N 15W 01 BBCAC	26-Apr-94	WELL		36.5	8.8	4.3	<1.5	<0.03	<0.005	16.28	148.7		.9	1.8	.3		<0.5
16N 15W 01 BBCAC	21-Jun-94	WELL		43.1	9.4	3.9	<1.5	<0.03	<0.005	16.28	134.1		1.	1.8	.4		<0.5
16N 15W 01 BBCCA	10-Aug-93	WELL		44.4	13.8	8.1	<1.5	<0.03	<0.005	17.18			.7	3.	<0.1		<0.5
16N 15W 01 BBCCA	29-Sep-93	WELL		43.1	14.1	8.1	1.5	<0.03	<0.005	17.40	195.1		.9	2.8	.1		<0.5
16N 15W 01 BBCCA	8-Nov-93	WELL		41.4	13.4	7.6	2.1	<0.03	<0.005	15.62	186.5		.7	2.7	.1		<0.5
16N 15W 01 BCAAD	24-Aug-93	WELL		44.3	10.7	4.5	1.9	<0.03	<0.005	14.28			.7	2.1	.3		<0.5
16N 15W 01 BCAAD	29-Sep-93	WELL		45.8	10.9	5.4	<1.5	<0.03	<0.005	16.06	182.9		.9	2.3	.3		<0.5
16N 15W 01 BCAAD	25-Jan-94	WELL		43.7	11.5	4.2	4.1	<0.03	<0.005	14.50	175.6		1.1	2.2	.4		<0.5
16N 15W 01 BCAAD	29-Mar-94	WELL		42.7	10.9	4.6	2.1	<0.03	<0.005	14.50	175.6		.8	2.2	.3		<0.5
16N 15W 01 BCAAD	26-Apr-94	WELL		45.1	11.1	4.9	<1.5	<0.03	<0.005	15.17	173.1		.8	2.3	.4		<0.5
16N 15W 01 BCAAD	21-Jun-94	WELL		62.9	12.	7.8	<1.5	<0.03	<0.005	18.07	200.0		.7	2.3	.2		<0.5
16N 15W 01 BCADA	24-Aug-93	WELL		47.4	11.	7.4	1.9	<0.03	.015	16.73			.6	2.9	.2		<0.5
16N 15W 01 BCADA	8-Nov-93	WELL		45.7	10.8	6.9	2.1	<0.03	.014	16.95	182.9		.6	2.8	.2		<0.5
16N 15W 01 BCADA	25-Jan-94	WELL		49.	11.6	7.4	4.	<0.03	<0.005	17.18	190.2		.8	2.6	.3		<0.5
16N 15W 01 BCADA	22-Feb-94	WELL		48.9	11.6	7.2	2.	<0.03	<0.005	17.62	151.2		.7	2.8	.2		<0.5
16N 15W 01 BCCBA	24-Aug-93	WELL		40.3	10.4	4.7	2.	<0.03	<0.005	16.51			.6	1.1	.2		<0.5
16N 15W 01 BCCBA	8-Nov-93	WELL		37.9	10.6	4.9	2.	<0.03	<0.005	16.73	163.4		.6	1.3	.2		<0.5
16N 15W 01 BCCBA	25-Jan-94	WELL		43.	11.4	5.1	1.6	<0.03	<0.005	17.85	175.6		.9	1.3	.2		<0.5
16N 15W 01 BCCBA	22-Feb-94	WELL		41.7	11.	4.9	2.1	<0.03	<0.005	17.40	154.8		.7	1.1	.2		<0.5
16N 15W 01 BCCBA	29-Mar-94	WELL		39.5	10.9	4.9	2.	<0.03	<0.005	17.18	143.9		1.4	1.2	.2		<0.5
16N 15W 01 BCCBA	26-Apr-94	WELL		41.3		5.2	1.5	<0.03	<0.005	17.40	160.9		.6	1.1	.2		<0.5
16N 15W 01 BCCBA	21-Jun-94	WELL		49.6	12.2	5.2	<1.5	<0.03	<0.005	17.18	173.1		.8	1.1	.2		<0.5
16N 15W 01 BDCCB	25-Jan-94	WELL		60.1	12.6	7.4	3.6	<0.03	<0.005	18.07	229.2		1.2	2.	.1		<0.5
16N 15W 01 BDCCB	22-Feb-94	WELL		59.	12.6	7.1	1.7	<0.03	<0.005	17.85	209.7		.8	1.9	.1		<0.5
< - Denotes detection limit. Limits may vary depending on total dissolved, presence of interfering ions, or analytical procedures.																	
16N 15W 01 BDCCB	29-Mar-94	WELL		NA	NA	NA	NA	NA	NA		219.5		.9	1.9	.1		<0.5
16N 15W 01 BDCCB	21-Jun-94	WELL		67.81	13.9	7.9	<1.5	<0.03	<0.005	17.85	214.6		1.	2.8	.1		<0.5
16N 15W 01 BDCCD	1-Sep-93	WELL		55.5	12.5	6.1	1.5	<0.03	<0.005	17.40	208.5		.9	1.7	.2		<0.5
16N 15W 01 BDCCD	29-Sep-93	WELL		54.6	12.3	5.9	<1.5	<0.03	<0.005	17.62	215.8		1.	1.8	.2		<0.5
16N 15W 01 BDCCD	8-Nov-93	WELL		52.2	11.2	5.3	1.9	<0.03	<0.005	17.18	207.3		.8	1.8	.2		<0.5
16N 15W 01 BDCCD	22-Feb-94	WELL		58.6	12.8	6.	1.8	<0.03	<0.005	17.85	204.8		1.	1.7	.2		<0.5
16N 15W 01 BDCCD	26-Apr-94	WELL		53.5	11.9	6.1	<1.5	<0.03	<0.005	17.40	209.7		.8	1.7	.2		<0.5

Seeley Lake ground-water data - major elements

LOCATION	SAMPLE DATE	SAMPLE SOURC	MIBMG QW #	Ca (mg/L)	Mg (mg/L)	Na (mg/L)	K (mg/L)	Fe (mg/L)	Mn (mg/L)	SiO2 (mg/L)	HCO3 (mg/L)	CO3 (mg/L)	Cl (mg/L)	SO4 (mg/L)	NO3 as N (mg/L)	F (mg/L)	PO4 as P (mg/L)
16N 15W 02 AADDD	21-Jun-94	WELL		50.11	11.8	4.7	<1.5	<0.03	<0.005	16.73	158.5		2.5	1.8	2.3		<0.5
16N 15W 02 ABCAC	22-Jul-97	WELL	98Q0064	29.4	16.4	5.9	1.	.06	.043	15.30	181.1		.81	<2.5	<.05		<.05
16N 15W 02 BCCBBC	22-Feb-94	WELL		26.6	8.5	8.3	3.6	1.64	<0.005	22.31	102.4		2.6	3.4	.1		<0.5
16N 15W 02 BCCBBC	29-Mar-94	WELL		27.	8.4	4.4	4.6	.34	.263	15.39	112.2		1.8	.6	.1		<0.5
16N 15W 02 BCCBBC	26-Apr-94	WELL		27.9	8.9	4.3	3.1	.06	.253	13.38	124.4		.9	1.4	.		<0.5
16N 15W 02 BCCBBC	21-Jun-94	WELL		31.8	9.6	4.8	2.3	.08	.255	13.61	117.0		2.8	13.6	.1		<0.5
16N 15W 03 AAAAB 01	20-May-97	WELL	97Q0796	22.	16.9	9.7	1.4	<.003	.029	15.50	177.6		.78	<2.5	.06		<1
16N 15W 03 ABDCBC	29-Mar-94	WELL		18.	7.6	9.4	4.3	.54	.153	28.55	73.2		11.5	9.8	<0.1		<0.5
16N 15W 03 ABDCBC	26-Apr-94	WELL		17.4	8.2	6.6	3.6	.52	.136	27.44	75.6		11.4	10.8	<0.1		<0.5
16N 15W 03 ABDCBC	21-Jun-94	WELL		21.5	10.2	6.6	2.6	.76	.122	29.22	75.6		8.3	1.	<0.1		<0.5
16N 15W 03 ABDCBC	15-Oct-97	WELL	98Q0518	19.4	10.8	6.7	2.9	1.694	.062	25.90	88.6		21.68	10.85	<0.25		<.05
16N 15W 03 ADDBB	15-Oct-97	WELL	98Q0515	33.4	10.11	3.8	.9	.019	.129	11.60	142.3		9.34	6.32	1.65	.08	<.05
16N 15W 03 CDCCAB	20-May-97	WELL	97Q0792	60.2	18.8	14.	2.3	4.	.509	10.00	93.8		40.58	23.5	27.		<1
16N 15W 03 DABBBB	29-Mar-94	WELL		182.	51.81	7.6	5.5	<0.03	3.341	27.22	668.2		11.7	5.2	.7		<0.5
16N 15W 03 DABBBB	26-Apr-94	WELL		116.	33.8	3.5	2.	.03	.586	20.97	475.5		16.8	5.3	2.6		<0.5
16N 15W 03 DABBBB	22-Jul-97	WELL	98Q0063	198.8	56.8	7.8	2.6	.093	1.1	24.60	854.0		12.	6.9	2.6		<.05
16N 15W 03 DADBAA	20-May-97	WELL	97Q0795	167.7	52.6	5.78	1.4	<.003	<.004	25.30	611.0		12.3	7.5	3.6		<1
16N 15W 03 DDABCA	20-May-97	WELL	97Q0797	90.8	27.14	3.2	.88	<.003	<.004	17.00	345.1		6.97	6.	3.3		<1
16N 15W 10 BAADBA 01	20-May-97	WELL	97Q0807	35.05	9.97	5.29	.88	<.003	<.002	16.57	119.3		10.4	7.6	6.3		<.05
16N 15W 11 ABCBD	28-Oct-97	WELL	98Q0545	17.7	8.03	45.8	1.05	.031	.008	12.5	221.8	11.5	1.14	5.4	<0.25	.42	<.05
16N 15W 11 ACABB	29-Oct-97	WELL	98Q0547	28.7	8.3	11.9	1.12	<.005	<.001	13.2	147.1	6.72	1.35	7.34	<0.25	.12	<.05
16N 15W 11 ACCCA	28-Oct-97	WELL	98Q0544	28.3	7.7	2.3	.62	<.005	<.001	8.9	154.7		1.35	4.11	<0.25	<.05	<.05
16N 15W 12 BBBB	15-Oct-97	WELL	98Q0517	46.1	10.1	6.1	.82	.056	.004	13.60	183.9	13.2	.85	2.9	<0.25	.08	<.05
16N 15W 12 BBBBD	15-Oct-97	WELL	98Q0516	45.9	9.3	5.9	.67	.012	.005	13.60	189.6	7.	.79	2.72	<0.25	.06	<.05
17N 15W 33 BDAAB	21-Jun-94	WELL		45.5	13.3	12.5	3.8	4.85	2.427	45.51			3.4	3.3	.3		<0.5
17N 15W 33 BDADA	21-Jun-94	WELL		36.8	17.6	30.3	4.9	.08	1.707	48.18	146.3		11.4	8.9	4.7		<0.5
17N 15W 33 BDDDA	21-Jun-94	WELL		4.2	2.	23.6	9.5	4.72	.151	56.88	175.6		10.3	3.4	2.3		<0.5

Seeley Lake ground-water data - trace elements

LOCATION	SAMPLE DATE	SAMPLE SOURCE	MBMG GW #	Aluminum, Al (ug/L)	Antimony, Sb (ug/L)	Arsenic, As (ug/L)	Barium, Ba (ug/L)	Beryllium, Be (ug/L)	Boron, B (ug/L)	Bromide, Br (ug/L)	Cadmium, Cd (ug/L)	Chromium, Cr (ug/L)	Cobalt, Co (ug/L)	Copper, Cu (ug/L)	Lead, Pb (ug/L)	Lithium, Li (ug/L)	Molybdenum, Mo (ug/L)	Nickel, Ni (ug/L)	Nitrite, NO ₂ as N (mg/L)	Phosphorous, P tot (mg/L)	Selenium, Se (ug/L)	Silver, Ag (ug/L)	Strontium, Sr (ug/L)	Titanium, Ti (ug/L)	Vanadium, Va (ug/L)	Zinc, Zn (ug/L)	Zirconium, Zr (ug/L)	
16N 15W 01 BABAA	8-Nov-93	WELL												<10.0	<100.0	<10.0	<20.0	<20.0	<0.21				90.	<50.0			17.	
16N 15W 01 BABAA	25-Jan-94	WELL												<10.0	<100.0	<10.0	<20.0	<20.0	.5				80.	<50.0			12.	
16N 15W 01 BABAA	22-Feb-94	WELL												<10.0	<100.0	<10.0	<20.0	<20.0	.2				100.	<50.0			19.	
16N 15W 01 BACAA	1-Sep-93	WELL												<10.0	<100.0	NA	NA	NA	NA				NA	NA	NA		103.	
16N 15W 01 BACAA	29-Sep-93	WELL												<10.0	<100.0	<10.0	<20.0	<20.0	<0.2				NA	NA	NA		100.	
16N 15W 01 BBAAA	24-Aug-93	WELL												<10.0	<100.0	NA	NA	NA	NA				NA	NA	NA		20.	
16N 15W 01 BBAAA	29-Sep-93	WELL												<10.0	<100.0	<10.0	<20.0	<20.0	<0.2				80.	<50.0			28.	
16N 15W 01 BBAAA	29-Mar-94	WELL												<10.0	<100.0	<10.0	<20.0	<20.0	<0.2				<50	<50.0			5.	
16N 15W 01 BBAAA	21-Jun-94	WELL												10.	<100.0	<10.0	<20.0	<20.0	.3				<50.0	<50.0			15.	
16N 15W 01 BBACB	10-Aug-93	WELL												<10.0	<100.0	NA	NA	NA	NA				NA	NA	NA		60.	
16N 15W 01 BBACB	8-Nov-93	WELL												<10.0	<100.0	<10.0	<20.0	<20.0	<0.2				80.	<50.0			29.	
16N 15W 01 BBACB	25-Jan-94	WELL												<10.0	<100.0	<10.0	<20.0	<20.0	.6				80.	<50.0			42.	
16N 15W 01 BBACB	22-Feb-94	WELL												<10.0	<100.0	<10.0	<20.0	<20.0	.2				80.	<50.0			31.	
16N 15W 01 BBACB	29-Mar-94	WELL												<10.0	<100.0	<10.0	<20.0	<20.0	<0.2				80.	<50.0			79.	
16N 15W 01 BBACB	26-Apr-94	WELL												<10.0	<100.0	<10.0	<20.0	<20.0	.2				80.	<50.0			86.	
16N 15W 01 BBBCA	24-Aug-93	WELL												<10.0	<100.0	NA	NA	NA	NA				NA	NA	NA		47.	
16N 15W 01 BBBCA	29-Sep-93	WELL												<10.0	<100.0	<10.0	<20.0	<20.0	<0.2				50.	<50.0			41.	
16N 15W 01 BBBCA	21-Jun-94	WELL												<10.0	<100.0	<10.0	<20.0	<20.0	.3				70.	<50.0			13.	
16N 15W 01 BBBCB	24-Aug-93	WELL												<10.0	<100.0	NA	NA	NA	NA				NA	NA	NA		26.	
16N 15W 01 BBBCB	25-Jan-94	WELL												<10.0	<100.0	<10.0	<20.0	<20.0	.6				60.	<50.0			853.	
16N 15W 01 BBBCB	22-Feb-94	WELL												<10.0	<100.0	<10.0	<20.0	<20.0	.2				60.	<50.0			321.	
16N 15W 01 BBBCB	29-Mar-94	WELL												<10.0	<100.0	<10.0	<20.0	<20.0	<0.2				60.	<50.0			478.	
16N 15W 01 BBBCB	26-Apr-94	WELL												<10.0	<100.0	<10.0	<20.0	<20.0	.2				60.	<50.0			518.	
16N 15W 01 BBBCAC	24-Aug-93	WELL												<10.0	<100.0	NA	NA	NA	NA				NA	NA	NA		42.	
16N 15W 01 BBBCAC	29-Sep-93	WELL												<10.0	<100.0	<10.0	<20.0	<20.0	<0.2				50.	<50.0			49.	
16N 15W 01 BBBCAC	8-Nov-93	WELL												<10.0	<100.0	<10.0	<20.0	<20.0	<0.2				50.	<50.0			14.	
16N 15W 01 BBBCAC	25-Jan-94	WELL												<10.0	<100.0	<10.0	<20.0	<20.0	.5				60.	<50.0			23.	
16N 15W 01 BBBCAC	22-Feb-94	WELL												<10.0	<100.0	<10.0	<20.0	<20.0	.2				60.	<50.0			30.	
16N 15W 01 BBBCAC	29-Mar-94	WELL												<10.0	<100.0	<10.0	<20.0	<20.0	<0.2				50.	<50.0			64.	
16N 15W 01 BBBCAC	26-Apr-94	WELL												<10.0	<100.0	<10.0	<20.0	<20.0	<0.2				50.	<50.0			41.	
< - Denotes detection limit. Limits may vary depending on total dissolved, presence of interfering ions, or analytical procedures.																												
16N 15W 01 BBBCAC	21-Jun-94	WELL												<10.0	<100.0	<10.0	<20.0	<20.0	.3				50.	<50.0			35.	
16N 15W 01 BBCCA	10-Aug-93	WELL												<10.0	<100.0	NA	NA	NA	NA				NA	NA	NA		178.	
16N 15W 01 BBCCA	29-Sep-93	WELL												<10.0	<100.0	<10.0	<20.0	<20.0	<0.2				90.	<50.0			329.	
16N 15W 01 BBCCA	8-Nov-93	WELL												<10.0	<100.0	<10.0	<20.0	<20.0	<0.2				80.	<50.0			363.	

Seeley Lake ground-water data - trace elements

LOCATION	SAMPLE DATE	SAMPLE SOURCE	MBMG GW #	Aluminum, Al (ug/L)	Antimony, Sb (ug/L)	Arsenic, As (ug/L)	Barium, Ba (ug/L)	Beryllium, Be (ug/L)	Boron, B (ug/L)	Bromide, Br (ug/L)	Cadmium, Cd (ug/L)	Chromium, Cr (ug/L)	Cobalt, Co (ug/L)	Copper, Cu (ug/L)	Lead, Pb (ug/L)	Lithium, Li (ug/L)	Molybdenum, Mo (ug/L)	Nickel, Ni (ug/L)	Nitrite, NO ₂ as N (mg/L)	Phosphorous, P tot (mg/L)	Selenium, Se (ug/L)	Silver, Ag (ug/L)	Strontium, Sr (ug/L)	Titanium, Ti (ug/L)	Vanadium, Va (ug/L)	Zinc, Zn (ug/L)	Zirconium, Zr (ug/L)	
16N 15W 01 BCAA	24-Aug-93	WELL												<10.0	<100.0		NA	NA					NA	NA			42.	
16N 15W 01 BCAA	29-Sep-93	WELL												<10.0	<100.0		<10.0	<20.0		<0.2			70.	<50.0			42.	
16N 15W 01 BCAA	25-Jan-94	WELL												<10.0	<100.0		<10.0	<20.0		.5			60.	<50.0			27.	
16N 15W 01 BCAA	29-Mar-94	WELL												<10.0	<100.0		<10.0	<20.0		<0.2			60.	<50.0			66.	
16N 15W 01 BCAA	26-Apr-94	WELL												<10.0	<100.0		<10.0	<20.0		<0.2			70.	<50.0			56.	
16N 15W 01 BCAA	21-Jun-94	WELL												<10.0	<100.0		<10.0	<20.0		.3			80.	<50.0			42.	
16N 15W 01 BCADA	24-Aug-93	WELL												<10.0	<100.0		NA	NA					NA	NA			52.	
16N 15W 01 BCADA	8-Nov-93	WELL												<10.0	<100.0		<10.0	<20.0		<0.21			70.	<50.0			39.	
16N 15W 01 BCADA	25-Jan-94	WELL												<10.0	<100.0		<10.0	<20.0		.5			80.	<50.0			73.	
16N 15W 01 BCADA	22-Feb-94	WELL												<10.0	<100.0		<10.0	<20.0		.2			80.	<50.0			33.	
16N 15W 01 BCCBA	24-Aug-93	WELL												<10.0	<100.0		NA	NA		NA			NA	NA			218.	
16N 15W 01 BCCBA	8-Nov-93	WELL												<10.0	<100.0		<10.0	<20.0		<0.2			70.	<50.0			147.	
16N 15W 01 BCCBA	25-Jan-94	WELL												<10.0	<100.0		<10.0	<20.0		.2			70.	<50.0			172.	
16N 15W 01 BCCBA	22-Feb-94	WELL												<10.0	<100.0		<10.0	<20.0		.2			70.	<50.0			203.	
16N 15W 01 BCCBA	29-Mar-94	WELL												<10.0	<100.0		<10.0	<20.0		<0.2			70.	<50.0			143.	
16N 15W 01 BCCBA	26-Apr-94	WELL												<10.0	<100.0		<10.0	<20.0		<0.2			70.	<50.0			159.	
16N 15W 01 BCCBA	21-Jun-94	WELL												<10.0	<100.0		<10.0	<20.0		.4			70.	<50.0			301.	
16N 15W 01 BDCCB	25-Jan-94	WELL												<10.0	<100.0		<10.0	<20.0		.6			90.	<50.0			59.	
16N 15W 01 BDCCB	22-Feb-94	WELL												<10.0	<100.0		<10.0	<20.0		.2			80.	<50.0			128.	
16N 15W 01 BDCCB	29-Mar-94	WELL												NA	NA		NA	NA		NA			NA	NA			NA	
16N 15W 01 BDCCB	21-Jun-94	WELL												<10.0	<100.0		<10.0	<20.0		.3			90.	<50.0			86.	
16N 15W 01 BDCCD	1-Sep-93	WELL												<10.0	<100.0		NA	NA		NA			NA	NA			83.	
16N 15W 01 BDCCD	29-Sep-93	WELL												<10.0	<100.0		<10.0	<20.0		<0.2			80.	<50.0			64.	
16N 15W 01 BDCCD	8-Nov-93	WELL												<10.0	<100.0		<10.0	<20.0		.2			70.	<50.0			26.	
16N 15W 01 BDCCD	22-Feb-94	WELL												<10.0	<100.0		<10.0	<20.0		.2			80.	<50.0			35.	
16N 15W 01 BDCCD	26-Apr-94	WELL												<10.0	<100.0		<10.0	<20.0		<0.2			80.	<50.0			26.	
< - Denotes detection limit. Limits may vary depending on total dissolved, presence of interfering ions, or analytical procedures.																												
16N 15W 01 CABCD	1-Sep-93	WELL												<10.0	<100.0		NA	NA		NA			NA	NA			69.	
16N 15W 01 CABCD	25-Jan-94	WELL												<10.0	<100.0		<10.0	<20.0		<0.2			60.	<50.0			17.	
16N 15W 01 CABCD	29-Mar-94	WELL												<10.0	<100.0		<10.0	<20.0		<0.2			90.	<50.0			32.	
16N 15W 01 CACCA	1-Sep-93	WELL												<10.0	<100.0		NA	NA		NA			NA	NA			119.	
16N 15W 01 CACCA	29-Sep-93	WELL												<10.0	<100.0		<10.0	<20.0		<0.2			80.	<50.0			72.	
16N 15W 01 CACCA	8-Nov-93	WELL												<10.0	<100.0		<10.0	<20.0		.2			80.	<50.0			68.	
16N 15W 01 CACCA	26-Apr-94	WELL												<10.0	<100.0		<10.0	<20.0		<0.2			80.	<50.0			58.	
16N 15W 01 CBAAB	1-Sep-93	WELL												<10.0	<100.0		NA	NA		NA			NA	NA			52.	

Seeley Lake ground-water data - trace elements

LOCATION	SAMPLE DATE	SAMPLE SOURCE	MBMG GW #	Aluminum, Al (ug/L)	Antimony, Sb (ug/L)	Arsenic, As (ug/L)	Barium, Ba (ug/L)	Beryllium, Be (ug/L)	Boron, B (ug/L)	Bromide, Br (ug/L)	Cadmium, Cd (ug/L)	Chromium, Cr (ug/L)	Cobalt, Co (ug/L)	Copper, Cu (ug/L)	Lead, Pb (ug/L)	Lithium, Li (ug/L)	Molybdenum, Mo (ug/L)	Nickel, Ni (ug/L)	Nitrite, NO ₂ as N (mg/L)	Phosphorous, P tot (mg/L)	Selenium, Se (ug/L)	Silver, Ag (ug/L)	Strontium, Sr (ug/L)	Titanium, Ti (ug/L)	Vanadium, Va (ug/L)	Zinc, Zn (ug/L)	Zirconium, Zr (ug/L)	
16N 15W 01 CBAAB	29-Mar-94	WELL												<10.0	<100.0	<10.0	<20.0	<20.0	<0.2	<0.2			80.	<50.0			37.	
16N 15W 01 CBABC	24-Aug-93	WELL												<10.0	<100.0	NA	NA	NA	NA	NA			NA	NA			121.	
16N 15W 01 CBABC	8-Nov-93	WELL												<10.0	<100.0	<10.0	<20.0	<20.0	.2	<0.2			80.	<50.0			39.	
16N 15W 01 CBABC	25-Jan-94	WELL												<10.0	<100.0	<10.0	<20.0	<20.0	<0.2	<0.2			80.	<50.0			59.	
16N 15W 01 CBABC	22-Feb-94	WELL												<10.0	<100.0	<10.0	<20.0	<20.0	.2	<0.2			80.	<50.0			56.	
16N 15W 01 CBABC	29-Mar-94	WELL												<10.0	<100.0	<10.0	<20.0	<20.0	<0.2	<0.2			80.	<50.0			40.	
16N 15W 01 CCADB	24-Aug-93	WELL												<10.0	<100.0	NA	NA	NA	NA	NA			NA	NA			46.	
16N 15W 01 CCBCC	24-Aug-93	WELL												<10.0	<100.0	NA	NA	NA	NA	NA			NA	NA			528.	
16N 15W 01 CCBCC	29-Sep-93	WELL												<10.0	<100.0	<10.0	<20.0	<20.0	<0.2	<0.2			60.	<50.0			501.	
16N 15W 01 CCBCC	8-Nov-93	WELL												<10.0	<100.0	<10.0	<20.0	<20.0	<0.2	<0.2			60.	<50.0			161.	
16N 15W 01 CCBCC	25-Jan-94	WELL												<10.0	<100.0	<10.0	<20.0	<20.0	.2	<0.2			60.	<50.0			145.	
16N 15W 01 CCBCC	22-Feb-94	WELL												<10.0	<100.0	<10.0	<20.0	<20.0	.2	<0.2			60.	<50.0			187.	
16N 15W 01 CCBCC	29-Mar-94	WELL												<10.0	<100.0	<10.0	<20.0	<20.0	<0.2	<0.2			50.	<50.0			190.	
16N 15W 01 CCBCC	26-Apr-94	WELL												<10.0	<100.0	<10.0	<20.0	<20.0	<0.2	<0.2			<50.0	<50.0			338.	
16N 15W 01 CCBCC	21-Jun-94	WELL												<10.0	<100.0	<10.0	<20.0	<20.0	.4	<0.2			60.	<50.0			310.	
16N 15W 01 CDBBD	1-Sep-93	WELL												<10.0	<100.0	NA	NA	NA	NA	NA			NA	NA			60.	
16N 15W 01 CDBBD	25-Jan-94	WELL												<10.0	<100.0	<10.0	<20.0	<20.0	<0.2	<0.2			70.	<50.0			34.	
16N 15W 01 CDBBD	22-Feb-94	WELL												NA	NA	NA	NA	NA	NA	NA			NA	NA			NA	
16N 15W 01 CDBBD	29-Mar-94	WELL												NA	NA	NA	NA	NA	NA	NA			NA	NA			NA	
16N 15W 01 CDBBD	26-Apr-94	WELL												<10.0	<100.0	<10.0	<20.0	<20.0	<0.2	<0.2			60.	<50.0			46.	
16N 15W 01 CDBBD	21-Jun-94	WELL												<10.0	<100.0	<10.0	<20.0	<20.0	.3	<0.2			80.	<50.0			75.	
16N 15W 01 CDBDB	24-Aug-93	WELL												10.	<100.0	NA	NA	NA	NA	NA			NA	NA			481.	
< - Denotes detection limit. Limits may vary depending on total dissolved, presence of interfering ions, or analytical procedures.																												
16N 15W 01 CDBDB	29-Sep-93	WELL												<10.0	<100.0	<10.0	<20.0	<20.0	<0.2	<0.2			NA	NA			660.	
16N 15W 01 CDBDB	8-Nov-93	WELL												<10.0	<100.0	<10.0	<20.0	<20.0	<0.2	<0.2			80.	<50.0			454.	
16N 15W 01 CDBDB	8-Nov-93	WELL												<10.0	<100.0	<10.0	<20.0	<20.0	.6	<0.2			80.	<50.0			387.	
16N 15W 01 CDBDB	22-Feb-94	WELL												<10.0	<100.0	<10.0	<20.0	<20.0	.2	<0.2			80.	<50.0			1,145.	
16N 15W 01 CDBDB	29-Mar-94	WELL												<10.0	<100.0	<10.0	<20.0	<20.0	<0.2	<0.2			80.	<50.0			498.	
16N 15W 01 CDBDB	26-Apr-94	WELL												<10.0	<100.0	<10.0	<20.0	<20.0	<0.2	<0.2			80.	<50.0			548.	
16N 15W 01 CDBDB	21-Jun-94	WELL												20.	<100.0	<10.0	<20.0	<20.0	.3	<0.2			80.	<50.0			577.	
16N 15W 01 CDCCA	1-Sep-93	WELL												<10.0	<100.0	NA	NA	NA	NA	NA			NA	NA			113.	
16N 15W 01 CDCCA	29-Sep-93	WELL												<10.0	<100.0	<10.0	<20.0	<20.0	<0.2	<0.2			70.	<50.0			58.	
16N 15W 01 CDCCA	8-Nov-93	WELL												<10.0	<100.0	<10.0	<20.0	<20.0	.2	<0.2			70.	<50.0			38.	
16N 15W 01 CDCCA	25-Jan-94	WELL												<10.0	<100.0	<10.0	<20.0	<20.0	<0.2	<0.2			70.	<50.0			65.	
16N 15W 01 CDCCA	29-Mar-94	WELL												<10.0	<100.0	<10.0	<20.0	<20.0	<0.2	<0.2			80.	<50.0			55.	

Seeley Lake ground-water data - trace elements

LOCATION	SAMPLE DATE	SAMPLE SOURCE	MBMG GW #	Aluminum, Al (ug/L)	Antimony, Sb (ug/L)	Arsenic, As (ug/L)	Barium, Ba (ug/L)	Beryllium, Be (ug/L)	Boron, B (ug/L)	Bromide, Br (ug/L)	Cadmium, Cd (ug/L)	Chromium, Cr (ug/L)	Cobalt, Co (ug/L)	Copper, Cu (ug/L)	Lead, Pb (ug/L)	Lithium, Li (ug/L)	Molybdenum, Mo (ug/L)	Nickel, Ni (ug/L)	Nitrite, NO2 as N (mg/L)	Phosphorous, P tot (mg/L)	Selenium, Se (ug/L)	Silver, Ag (ug/L)	Strontium, Sr (ug/L)	Titanium, Ti (ug/L)	Vanadium, Va (ug/L)	Zinc, Zn (ug/L)	Zirconium, Zr (ug/L)	
16N 15W 01 CDCCA	26-Apr-94	WELL												<10.0	<100.0	<10.0	<20.0	<20.0	<0.2	<0.2			70.	<50.0			62.	
16N 15W 01 CDCCA	21-Jun-94	WELL												<10.0	<100.0	<10.0	<20.0	<20.0	.3				80.	<50.0			78.	
16N 15W 02 AAACB	10-Aug-93	WELL												<10.0	<100.0	NA	NA	NA	NA				NA	NA	NA		130.	
16N 15W 02 AAACB	29-Sep-93	WELL												<10.0	<100.0	<10.0	<20.0	<20.0	<0.2	<0.2			70.	<50.0			205.	
16N 15W 02 AAACB	8-Nov-93	WELL												<10.0	<100.0	<10.0	<20.0	<20.0	.2	.2			70.	<50.0			157.	
16N 15W 02 AAACB	25-Jan-94	WELL												<10.0	<100.0	<10.0	<20.0	<20.0	<0.2	<0.2			70.	<50.0			183.	
16N 15W 02 AAACB	29-Mar-94	WELL												<10.0	<100.0	<10.0	<20.0	<20.0	<0.2	<0.2			70.	<50.0			153.	
16N 15W 02 AAACB	26-Apr-94	WELL												<10.0	<100.0	<10.0	<20.0	<20.0	<0.2	<0.2			70.	<50.0			191.	
16N 15W 02 AAACB	21-Jun-94	WELL												<10.0	<100.0	<10.0	<20.0	<20.0	.3	.3			70.	<50.0			130.	
16N 15W 02 AAACB	29-Oct-97	WELL	98Q0543	<30	<2	<1	180.3	<2	<30	<25	<2	<2	<2	<2	<2	<5	<10	5.4		<0.1	<1	<1	67.1	10.9	<5		29.7	<5
16N 15W 02 AABBA	28-Oct-97	WELL	98Q0546	<30	<2	<1	178.9	<2	<30	<25	<2	<2	<2	<2	<2	<5	<10	4.8		<0.1	<1	<1	58.1	<10	<5		18.5	<5
16N 15W 02 AADDD	10-Aug-93	WELL												<10.0	<100.0	NA	NA	NA	NA				NA	NA	NA		57.	
16N 15W 02 AADDD	29-Sep-93	WELL												<10.0	<100.0	<10.0	<20.0	<20.0	<0.2	<0.2			60.	<50.0			29.	
16N 15W 02 AADDD	8-Nov-93	WELL												<10.0	<100.0	<10.0	<20.0	<20.0	.2	.2			60.	<50.0			27.	
16N 15W 02 AADDD	25-Jan-94	WELL												<10.0	<100.0	<10.0	<20.0	<20.0	.2	.2			100.	<50.0			14.	
16N 15W 02 AADDD	22-Feb-94	WELL												<10.0	<100.0	<10.0	<20.0	<20.0	.2	.2			60.	<50.0			16.	
16N 15W 02 AADDD	29-Mar-94	WELL												<10.0	<100.0	<10.0	<20.0	<20.0	<0.2	<0.2			60.	<50.0			40.	
16N 15W 02 AADDD	26-Apr-94	WELL												<10.0	<100.0	<10.0	<20.0	<20.0	<0.2	<0.2			70.	<50.0			23.	
< - Denotes detection limit. Limits may vary depending on total dissolved, presence of interfering ions, or analytical procedures.																												
16N 15W 02 AADDD	21-Jun-94	WELL												<10.0	<100.0	<10.0	<20.0	<20.0	.3	.3			70.	<50.0			16.	
16N 15W 02 ABCAC	22-Jul-97	WELL	98Q0064	<30	<2	<1	254.4	<2	<30	<25	<2	3.8	<2	<2	<2	<6	<10	2.1		<2	<2	<1	79.	<5	<5		<2	<20
16N 15W 02 BCCBBC	22-Feb-94	WELL												<10.0	<100.0	<10.0	<20.0	<20.0	.3	.3			30.	<50.0			74.	
16N 15W 02 BCCBBC	29-Mar-94	WELL												<10.0	<100.0	30.	<20.0	<20.0	<0.2	<0.2			<50.0	<50.0			40.	
16N 15W 02 BCCBBC	26-Apr-94	WELL												<10.0	<100.0	20.	<20.0	<20.0	<0.2	<0.2			<50.0	<50.0			14.	
16N 15W 02 BCCBBC	21-Jun-94	WELL												<10.0	<100.0	30.	<20.0	<20.0	.3	.3			<50.0	<50.0			21.	
16N 15W 03 AAAAB 0	20-May-97	WELL	97Q0796	<30	<3	<2	129.1	<2	<30	<25	<2	3.5	<2	4.4	<2	<10	<10	2.8	<0.05	<2	<1	<1	73.	<10	<5		16.9	<20
16N 15W 03 ABCBC	29-Mar-94	WELL												<10.0	<100.0	<10.0	<20.0	<20.0	<0.2	<0.2			<50.0	<50.0			58.	
16N 15W 03 ABCBC	26-Apr-94	WELL												<10.0	<100.0	<10.0	<20.0	<20.0	<0.2	<0.2			<50.0	<50.0			24.	
16N 15W 03 ABCBC	21-Jun-94	WELL												<10.0	<100.0	<10.0	<20.0	<20.0	.3	.3			<50.0	<50.0			50.	
16N 15W 03 ABCBC	15-Oct-97	WELL	98Q0518	124.9	<2	<1	290.2	<2	<30	247.	<2	<2	<2	<2	<2	<5	<10	3.5	<1	<1	1.4	<1	44.6	<10	<5		<15	<5
16N 15W 03 ADDBB	15-Oct-97	WELL	98Q0515	130.8	<2	<1	134.4	<2	<30	<25	<2	<2	<2	2.1	<2	<5	<10	<5	<1	<1	<1	43.6	17.	<5	<5		111.4	<5
16N 15W 03 CDCCAB	20-May-97	WELL	97Q0792	32.2	<3	<2	269.	<2	<30	<100	<2	2.6	<2	<2	<2	<10	<10	10.3	<0.05	<2	1.4	<1	95.	<10	<5		42.7	<20
16N 15W 03 DABBBB	29-Mar-94	WELL												<10.0	<100.0	<10.0	<20.0	<20.0	<0.2	<0.2			120.	<50.0			64.	
16N 15W 03 DABBBB	26-Apr-94	WELL												<10.0	<100.0	<10.0	<20.0	<20.0	<0.2	<0.2			70.	<50.0			14.	
16N 15W 03 DABBBB	22-Jul-97	WELL	98Q0063	57.5	<20	2.1	2,411.	<2	<30	273.	<2	22.8	<2	3.2	<20	7.	<10	18.1	<10	<2	<2	<1	149.	<10	6.		5.5	<20

Seeley Lake ground-water data - trace elements

LOCATION	SAMPLE DATE	SAMPLE SOURCE	MBMG GW #	Aluminum, Al (ug/L)	Antimony, Sb (ug/L)	Arsenic, As (ug/L)	Barium, Ba (ug/L)	Beryllium, Be (ug/L)	Boron, B (ug/L)	Bromide, Br (ug/L)	Cadmium, Cd (ug/L)	Chromium, Cr (ug/L)	Cobalt, Co (ug/L)	Copper, Cu (ug/L)	Lead, Pb (ug/L)	Lithium, Li (ug/L)	Molybdenum, Mo (ug/L)	Nickel, Ni (ug/L)	Nitrite, NO2 as N (mg/L)	Phosphorous, P tot (mg/L)	Selenium, Se (ug/L)	Silver, Ag (ug/L)	Strontium, Sr (ug/L)	Titanium, Ti (ug/L)	Vanadium, Va (ug/L)	Zinc, Zn (ug/L)	Zirconium, Zr (ug/L)
16N 15W 03 DADBAA	20-May-97	WELL	97Q0795	<30	<3	<2	1,668.	<2	32.3	<25	<2	10.3	<2	<2	<2	<10	<10	<10	13.1	<0.05	<2	<1	137.	<10	<5	<2	<20
16N 15W 03 DDABCA	20-May-97	WELL	97Q0797	<30	<3	<2	769.	<2	<30	<25	<2	8.	<2	<2	<2	<10	<10	9.4	<0.05	<22	<1	75.	<10	<5	10.5	<20	
16N 15W 10 BAADBA	20-May-97	WELL	97Q0807							<25									<0.05								
16N 15W 11 ABCBD	28-Oct-97	WELL	98Q0545	<30	<2	<1	66.7	<2	357.	<25	<2	<2	<2	<2	<2	<5	<10	2.3		<1	<1	57.1	<10	<5	4.4	<5	
16N 15W 11 ACABB	29-Oct-97	WELL	98Q0547	<30	<2	<1	181.9	<2	<30	<25	<2	<2	<2	25.7	<2	<5	<10	4.		<1	<1	47.	<10	<5	12.8	<5	
16N 15W 11 ACCCA	28-Oct-97	WELL	98Q0544	<30	<2	<1	143.1	<2	<30	<25	<2	<2	<2	<2	<2	<5	<10	4.1		<1	<1	41.4	<10	<5	18.4	<5	
16N 15W 12 BBBB	15-Oct-97	WELL	98Q0517	126.6	<2	<1	173.8	<2	<30	<25	<2	<2	<2	<2	<2	<5	<10	<5		<1	<1	68.5	<10	<5	26.1	<5	
16N 15W 12 BBBBD	15-Oct-97	WELL	98Q0516	106.2	<2	<1	148.8	<2	<30	<25	<2	<2	<2	<2	<2	<5	<10	<5		<1	<1	64.7	21.2	<5	30.7	<2	
17N 15W 33 BDAAB	21-Jun-94	WELL												10.	<100.0		10.	<20.0		.7		110.	<50.0		57.		
17N 15W 33 BDADA	21-Jun-94	WELL												10.	<100.0		<10.0	<20.0		.4		170.	<50.0		47.		
17N 15W 33 BDDDA	21-Jun-94	WELL												20.	<100.0		10.	<20.0		3.6		<50.0	53.		359.		

Appendix E

Seeley Lake septic tank information

Seeley Lake septic tanks

Location	Date installed	Replace?	Size of tank (gal)	Material made of	Depth to top of tank (ft)	Length of drain field (ft)	Width of trench (ft)	Depth of Drain Field (ft)	Elevation (ft)	Purpose of tank	No. households/businesses served	No. people served	Distance from nearest well (ft)	Remarks
16N 15W 01 AAA	1986		1000	Concrete	1.5	4-62.5' Laterals	36	4238	Household	1	3 Bedrooms	100+		
16N 15W 01 AABA	1988		1000	Concrete	1	4-60' Laterals	30	4208	Household	1	3 Bedrooms	100		
16N 15W 01 AABC	1990		1000	Concrete	1.2	3-83' Laterals	30	4205	Household	2 Trailers		100+		
16N 15W 01 ABAB	1984		1000	Concrete	1	210' Linear	14	4161	Household	1				
16N 15W 01 ABCB	1995		1000	Concrete	1	2-50' Laterals	24	4159	Commercial	1 Warehouse		100		
16N 15W 01 ABCB	1974		1000	Concrete	1.5	200' lin-3 laterals	18-24	4158	Household	1	2 Bedrooms	100+		
16N 15W 01 ABDCC	1977		1000	Fiberglass	1.5	190' Linear	18-24	4158	Household	1	2 Bedrooms	100+		
16N 15W 01 ACCA	1978		1000	Concrete	1	150' Linear	24-36	4196	Household	1	2 Bedrooms	100		
16N 15W 01 ACCC	1997		1000	Concrete	0.7	3-50' Laterals	30	4195	Household	1	1 Bedroom			
16N 15W 01 ACDC	1978	Y	1000	Concrete	1	3-60' Laterals	30	4158	Household	1	3 Bedrooms	100+		
16N 15W 01 ADC	1979		1000	Concrete	1	2-65' Laterals	30	4160	Household	1	2 Bedrooms	100+		
16N 15W 01 ADC	1979		1000	Concrete	1	200' Linear	24-36	4196	Household	1	2 Bedrooms	100+		
16N 15W 01 BAAA	1992		1000	Concrete	1	150 lin-3 laterals	24-36	4196	Household	1	2 Bedrooms	100+		
16N 15W 01 BAAAC	1993		1000	Concrete	1	4-50' Laterals	18-24	4196	Commercial	1 trailer, co. shop		100		
16N 15W 01 BABB	1993		1000	Concrete	1.5	2-75' Laterals	30	4185	Household	1	2 Bedrooms	100+		
16N 15W 01 BADAD	1995		1000	Concrete	1	4-75' Laterals	36	4185	Household	1	3 Bedrooms	100		
16N 15W 01 BADB	1995		1000	Concrete	1	240' Linear	24	4185	Household	1				
16N 15W 01 BADD	1994		1000	Concrete	2	190 lin-2 laterals	24	4193	Household	1	3 Bedrooms	100+		
16N 15W 01 BBBC	1994		1000	Concrete	0.5	3-60' Laterals	30	4190	Household	1	3 Bedrooms	100+		
16N 15W 01 BBBCD	1990		1000	Concrete	1	150 lin-2 laterals	24	4194	Household	1	2 Bedrooms	100+		
16N 15W 01 BBBD	1993		1000	Concrete	1	150' Linear	18-24	4187	Household	1	2 Bedrooms	100+		
16N 15W 01 BBBCA	1981		1000	Concrete	1	220' Linear	18-24	4187	Household	1	3 Bedrooms	100		
16N 15W 01 BBDB	1980		1000	Concrete	1	225' Linear	18-24	4182	Household	1	3 Bedrooms	100		
16N 15W 01 BBDC	1980		1000	Concrete	1	195 lin-3 laterals	24-36	4178	Household	1	3 Bedrooms	100		
16N 15W 01 BCAC	1995		1000	Concrete	1.5	290 lin-3 laterals	30	4173	Household	1	3 Bedrooms	100+		
16N 15W 01 BCAD	1992		1000	Concrete	1.3	3-63' Laterals	26	4173	Household	1	3 Bedrooms	100		
16N 15W 01 BCCBC	1983		1000	Concrete	1	200' Linear	18-20	4165	Household	1	3 Bedrooms	100		
16N 15W 01 BCCC	1978		1000	Concrete	1	200' Linear	24	4162	Household	1	2 Bedrooms	100		
16N 15W 01 BDBCC	1995		1000	Concrete	1	190 lin-4 laterals	24	4170	Household	1	2 Bedrooms	100		
16N 15W 01 BDCCA	1980		1000	Concrete	1	200' Linear	18-24	4162	Household	1	2 Bedrooms	100		
16N 15W 01 BDCCB	1992		1000	Concrete	1.5	2-100' Laterals	24-36	4165	Household	1	3 Bedrooms	100		
16N 15W 01 BDDB	1996		1000	Concrete	1	3-50' Laterals	32'	4167	Household	1				
16N 15W 01 CAAC	1989		1000	Concrete	1	150' Linear	4123	4123	Commercial	RV pump, shop		100+		
16N 15W 01 CAAC	1978		1000	Concrete	1	250' Linear	4152	4152	Household	1	1 Bedroom			
16N 15W 01 CAB	1983	Y	1000	Concrete	1	200' Linear	4157	4157	Household	1	3 Bedrooms			
16N 15W 01 CABA	1978		1000	Concrete	1	2-75' Laterals	24	4140	Household	1	2 Bedrooms	100+		
16N 15W 01 CAC	1990		1000	Concrete	1	225 lin- 4 laterals	30	4124	Household	1	2 Bedrooms			
16N 15W 01 CADA	1994		1000	Concrete	1	250' Linear	18-24	4125	Household	1	3 Bedrooms	100+		
16N 15W 01 CADC	1981		1000	Concrete	1		4160	4160	Household	1	3 Bedrooms			
16N 15W 01 CBAA	1996		1000	Concrete	0.7	187 lin-3 laterals	36	4159	Household	1	3 Bedrooms	150		
16N 15W 01 CBAD	1987		1000	Concrete	2	150' Linear	4158	4158	Household	1	3 Bedrooms			
16N 15W 01 CBBD	1972		1000	Concrete	2	165 lin 3 laterals	36	4158	Household	1	3 Bedrooms	100+		
16N 15W 01 CBC	1990		1000	Concrete	2				Household	1	3 Bedrooms	100+		

Seeley Lake septic tanks

Location	Date installed	Replace?	Size of tank (gal)	Material made of	Depth to top of tank (ft)	Length of drain field (ft)	Width of trench (ft)	Depth of Drain Field (ft)	Elevation (ft)	Purpose of tank	No. households/businesses served	No. people served	Distance from nearest well (ft)	Remarks
16N 15W 01 CBCA	1979		1000	Concrete	1	200' Linear	18-24	4157	Household	1	3 Bedrooms			
16N 15W 01 CBDD	1975		1000	Concrete		200 lin-3 laterals		4148	Household	1	2 Bedrooms	110		
16N 15W 01 CCAAC	1986		1000	Concrete	1.5	150' Linear	18-24	4137	Household	1	3 Bedrooms	100		
16N 15W 01 CCBA	1973		1000	Concrete		200 lin-3 laterals		4154	Household	1	2 Bedrooms			
16N 15W 01 CCBDB	1993	Y	1000	Concrete		200' Linear		4151	Household	1	2 Bedrooms			
16N 15W 01 CCBDC	1978		1000	Concrete		150' Linear		4145	Household	1	2 Bedrooms			
16N 15W 01 CDA	1993		1000	Concrete	0.8	2-100' Laterals	4-8	4120	Household	1	3 Bedrooms	100		300' to Stream
16N 15W 01 CDB	1993		1000	Fiberglass	1.5	190 lin-2 laterals		4135	Household	1	3 Bedrooms			was temporary line to a trailer until house was built
16N 15W 01 CDC	1992		1100	540 gal lift sta	8	3-70' Laterals	28	4121	Household	1	3 Bedrooms	100+		
16N 15W 01 CDCAA	1978	Y	1000	Concrete		6 ring seep pit		4123	Household	1	2 Bedrooms			
16N 15W 01 CDDB	1993		1000	Concrete		200' Linear		4118	Household	1	3 Bedrooms			
16N 15W 01 DAB	1979		1000	Concrete	1	250' Linear	24	4195	Household	1	2 Bedrooms	100+		
16N 15W 01 DCAD	1993	Y	1000	Concrete	1	200 lin-2 laterals	24-36	4166	Household	1	2 Bedrooms			
16N 15W 01 DCBBB	1995		1000	Concrete	0.7	3-70' Laterals	28	4120	Household	1	3 Bedrooms	120		
16N 15W 01 DCCD	1989		1000	Concrete	0.7	3-50' Laterals	32	4161	Household	1	2 Bedrooms	100		
16N 15W 01 DDBB	1985		1000	Concrete	0.8	3-50' Laterals	24	4190	Household	1	3 Bedrooms	100		
16N 15W 01 DDBC	1995		1000	Concrete	1.5	2-100' Laterals	36	4196	Household	1	3 Bedrooms	100		
16N 15W 02 AAAA	1995		1000	Concrete	1	3-50' Laterals	24	4196	Household	1	2 Bedrooms	100		
16N 15W 02 AAABC	1994	Y	1000	Concrete	5	200lin-3 laterals	24	4203	Church	church, house	3 Bedrooms			
16N 15W 02 AAACA	1979	Y	1000	Concrete	1	2-60' Laterals	18-24	4194	Household	1	2 Bedrooms			
16N 15W 02 AAACC	1995		1000	Concrete	4	3-50' Laterals	30	4200	Household	1	2 Bedrooms	100+		
16N 15W 02 AAACD	1992	Y	1000	Concrete	1	135 lin-2 laterals	36	4197	Household	1	2 Bedrooms			
16N 15W 02 AAADA	1994		1000	Concrete	1	2-75' Laterals	24-36	4191	Household	1	2 Bedrooms	100+		
16N 15W 02 AABAA	1979		1000	Concrete	1	170 lin-2 laterals	18	4200	Household	1	3 Bedrooms			
16N 15W 02 AABAB	1995	Y	1000	Concrete		20x30 bed-4 lat	24	4197	Household	1	3 Bedrooms	100		
16N 15W 02 AABBB	1979		1000	Concrete	1	170 lin-2 laterals	18	4197	Com. & HH	business, house	4 Bedrooms			Permit missing from the files.
16N 15W 02 AADBB	1986		1000	Concrete	1.5	2-95' Laterals	36	4200	Household	1	3 Bedrooms			
16N 15W 02 AADDC	1995		1000	Concrete	1.5	200' Linear		4204	Household	1	3 Bedrooms			
16N 15W 02 ABA	1970		900	Concrete		200' Linear		4204	Household	1	3 Bedrooms			
16N 15W 02 ADA	1981		1000	Concrete	1.5	350 lin-4 laterals	24	4090	Household	1	4 Bedrooms	100+		
16N 15W 02 BC	1996		1000	Concrete	1.7	450 lin-5 laterals	24	4060	School	3 trailers by school				
16N 15W 02 BCA	1993	Y	2-1000	Concrete		200' Linear		4083	Household	1	3 Bedrooms	100+ stream		
16N 15W 02 CAABB	1977		1000	Concrete	2	4-60' Laterals	18-20	4041	Household	1	2 Bedrooms	100+ stream		
16N 15W 02 CAB	1986		1000	Concrete	1	160 lin-4 laterals	18-24	4081	Household	1	2 Bedrooms			
16N 15W 02 CAD	1990		1000	Concrete	1.3	160 lin-3 laterals	24	4050	Household	1	2 Bedrooms			two tanks on this property, same year, double entry?
16N 15W 02 CBABB	1995		1000	Concrete	1	3-55' Laterals	18-24	4075	Household	1	2 Bedrooms			
16N 15W 02 CB BBB	1977		1000	Concrete	1	200' Linear PVC		4070	Household	1	2 Bedrooms			
16N 15W 02 CB BDA	1997		1000	Concrete	1	4-60' Laterals	36	4060	Household	1	3 Bedrooms			
16N 15W 02 CB CAC	1992		1000	Concrete	1	240 lin-4 laterals		4048	Household	1	3 Bedrooms			
16N 15W 02 CB CAD	1995		1000	Concrete	1	160 lin-4 laterals	18-24	4049	Household	1	2 Bedrooms			two tanks on this property, same year, double entry?
16N 15W 02 CB CBA	1980		1000	Concrete	1	150 lin-2 laterals	18-24	4061	Household	1	2 Bedrooms			
16N 15W 02 CB CBD	1977		1000	Concrete		200' Linear		4047	Household	1	3 Bedrooms			
16N 15W 02 CB CCB	1994		1000	Concrete		4-40' Laterals		4048	Household	1	2 Bedrooms	100		

Seeley Lake septic tanks

Location	Date installed	Replace?	Size of tank (gal)	Material made of	Depth to top of tank (ft)	Length of drain field (ft)	Width of trench (ft)	Depth of Drain Field (ft)	Elevation (ft)	Purpose of tank	No. households/businesses served	No. people served	Distance from nearest well (ft)	Remarks
16N 15W 02 CBCDD	1993								4049	Household	1	2 Bedrooms		
16N 15W 02 CBCDC	1991		1000			160' Linear			4048	Household	1	2 Bedrooms		
16N 15W 02 CBCDD	1983		1000	Concrete	1	2-75' Laterals	20-22	4048	Household	Household	1	1 Bedroom		
16N 15W 02 CBDAC	1984		1000	Concrete	0.7	150 lin-2 laterals	24-28	4040	Household	Household	1	2 Bedrooms	100 stream	
16N 15W 02 CBDDB	1993		1000	Concrete	1	320 lin-4 laterals	24-36	4055	Parsonage	Parsonage	1	4 Bedrooms		
16N 15W 02 CBDDB	1980		1000	Concrete	0.5	200' Linear PVC	18	4052	Household	Household	1	3 Bedrooms		
16N 15W 02 CBDDD	1988		1000	Concrete	1.7	2-80' Laterals	36	4040	Household	Household	1	2 Bedrooms	100	
16N 15W 02 CCAAA	1995		1000	Concrete	1.5	3-80' Laterals	24-36	4040	Household	Household	1	3 Bedrooms	100+	
16N 15W 02 CCABD	1987		1000	Concrete	2	150' Linear PVC	24	4040	Household	Household	1	2 Bedrooms		
16N 15W 02 CCACB	1991		1000	Concrete	1	240 lin-3 laterals	40	4048	Household	Household	1	3 Bedrooms		
16N 15W 02 CCADC	1983		1000	Concrete	1	3-80' Laterals	28-30	4038	Household	Household	1	3 Bedrooms	175' stream	
16N 15W 02 CCBBC	1983		1000	Concrete	1	3-70' Laterals	18-20	4048	Household	Household	1	3 Bedrooms		
16N 15W 02 CCBED	1995		1000	Concrete		240' Linear		4048	Household	Household	1	3 Bedrooms		
16N 15W 02 CCBDB	1991		1000	Concrete	1	160 lin-4 laterals	18-36	4050	Household	Household	1	2 Bedrooms		
16N 15W 02 CCBDC	1987		1000	Concrete	1	4-50' Laterals	30	4047	Household	Household	1	3 Bedrooms		
16N 15W 02 CCCC	1984		1000	Concrete	1.5-2	160' Linear-PVC	24-36	4040	Household	Household	1	2 Bedrooms		
16N 15W 02 CCCC	1976		1000	Concrete	1	210' Linear-PVC	18-24	4039	Household	Household	1	3 Bedrooms	100+	
16N 15W 02 CCCC	1983		1000	Concrete	1	3-70' Laterals	18-20	4040	Household	Household	1	3 Bedrooms		
16N 15W 02 CCCC	1988		1000	Concrete	0.7	4-60' Laterals	30	4039	Household	Household	1	3 Bedrooms		
16N 15W 02 CGDAB	1977		1000	Concrete	1	2-70' Laterals	24	4038	Household	Household	1			
16N 15W 02 CGDDB	1995		1000	Concrete				4039	Household	Household	1			
16N 15W 02 CGDDC	1979		1000	Concrete	1	220 lin-3 laterals	2	4038	Household	Household	1	3 Bedrooms		
16N 15W 02 CDBAD	1993		1000	Concrete	2	160 lin-2 laterals	18-24	4079	Household	Household	1	2 Bedrooms		
16N 15W 02 CDBB	1979		1000	Concrete	0.5	4-40' Laterals	24	4037	Household	Household	1	2 Bedrooms		
16N 15W 02 CDBD	1995		1000	Concrete		3-50' Laterals		4037	Household	Household	1	2 Bedrooms		
16N 15W 02 CDBDD	1992		1000	Concrete	2	3-55' Laterals	28	4039	Household	Household	1	2 Bedrooms		
16N 15W 02 CDCCC	1977		1000			150' Linear		4037	Household	Household	1	2 Bedrooms		
16N 15W 03 AAAAB	1992		1000	Concrete	1	150 lin-3 laterals	24	4090	Household	Household	1	2	100	
16N 15W 03 AAABA	1996		1000	Concrete	1	3-50' Laterals	24-36	4120	Household	Household	1	2 Bedrooms		
16N 15W 03 AAABB	1978		1000	Concrete	1.5	3-60' Laterals	30	4120	Household	Household	1	2 Bedrooms		
16N 15W 03 AAABC	1978		1000	Concrete		200' Linear		4100	Household	Household	1	2 Bedrooms		
16N 15W 03 AAABD	1991	Y	1000	Concrete	1	6' Ring Pit	12	4120	Household	Household	1	2 Bedrooms		
16N 15W 03 AAAC	1996		1000	Concrete	3	2-65' Laterals	20	4100	Household	Household	1	3 Bedrooms		
16N 15W 03 AAACB	1994		1000	Concrete	1	2-70' Laterals	24	4100	Household	Household	1	2 Bedrooms		
16N 15W 03 AAACD	1994		1000	Concrete	1.5	3-50' Laterals	24-36	4100	Household	Household	1	3 Bedrooms		
16N 15W 03 AAADA	1996	Y	1000	Concrete	1.5	3-50' Laterals	36	4130	Household	Household	1	3 Bedrooms		
16N 15W 03 AAADAD	1983		1000	Concrete	1	195' Linear PVC	24-30	4140	Household	Household	1	3 Bedrooms		
16N 15W 03 AAADB	1996		1000	Concrete		160' Linear		4120	Household	Household	1	2 Bedrooms		
16N 15W 03 AAADD	1993		1000	Concrete	1	150 lin-2 laterals	18-36	4140	Household	Household	1	2 Bedrooms		
16N 15W 03 AABAA	1996	Y	1000	Concrete				4100	Household	Household	1	3 Bedrooms		
16N 15W 03 AABAC	1994		1000	Concrete	1.5	2-75' Laterals	30	4080	Household	Household	1	2 Bedrooms		
16N 15W 03 AABCB	1977		1000	Concrete		150' Linear		4030	Household	Household	1	2 Bedrooms		
16N 15W 03 AABDA	1996		1000	Concrete	1	4-60' Laterals	34	4040	Household	Household	1	3 Bedrooms		
16N 15W 03 AABDB	1996		1000	Concrete	2	3-50' Laterals	24-36	4052	Household	Household	1	2 Bedrooms		

Seeley Lake septic tanks

Location	Date installed	Replace?	Size of tank (gal)	Material made of	Depth to top of tank (ft)	Length of drain field (ft)	Width of trench (ft)	Depth of Drain Field (ft)	Elevation (ft)	Purpose of tank	No. households/businesses served	No. people served	Distance from nearest well (ft)	Remarks
16N 15W 03 AABDB	1983		1000	Concrete	1.5/2	200' Linear PVC		30	4036	Household	1	3 Bedrooms		
16N 15W 03 AABDC	1983		1000	Concrete	1	150 lin-2 laterals		18-36	4040	Household	1	3 Bedrooms		
16N 15W 03 AACCC	1987		1500	Concrete	0.7	4-90' Laterals		30	4038	School	shower rooms		100+	
16N 15W 03 AACCC	1988	Y				4-100' Laterals		18-24	4038	School	1			
16N 15W 03 AADAB	1984		1000			180' Linear			4120	Household	1	2 Bedrooms		
16N 15W 03 AADBB	1979		1000	Concrete	1	200' Linear PVC		18	4072	Household	1	3 Bedrooms		
16N 15W 03 AADCC	1979		1000	Concrete	1	200' Linear PVC		18-24	4070	Household	1	2 Bedrooms		
16N 15W 03 AADDD	1979		1000	Concrete	1	200' Linear PVC		18-24	4112	Household	1	3 Bedrooms		
16N 15W 03 ABAAA	1985		1000	Concrete	1.5	160' Linear PVC		18-24	4029	Household	1	3 Bedrooms		
16N 15W 03 ABAAD	1983		1000	Concrete	1	150' Linear PVC		24-26	4029	Household	1	2 Bedrooms		
16N 15W 03 ABACA	1984	Y	1000	Concrete	3-3.3	200' Linear PVC		24-36	4018	Household	1	3 Bedrooms		
16N 15W 03 ABADD	1986		1000	Concrete	0.5	150 lin-6 laterals		18	4023	Household	1	3 Bedrooms		
16N 15W 03 ABAAA	1977		1000	Concrete	1	260' Linear PVC		18-24	4015	Church	church, trailer			
16N 15W 03 ABABA	1994	Y	1000	Concrete	0.5	3-50' Laterals		24-30	4022	Household	1	2 Bedrooms		
16N 15W 03 ABBCA	1989		1000	Concrete	0.7	150 lin-3 laterals		30	4021	Household	1	3 Bedrooms		
16N 15W 03 ABBCA	1981		1000	Concrete	1	6' Ring Pit			4021	Commercial	discount store			
16N 15W 03 ABBCB	1987		1000	Concrete	1.5-2	100' Linear PVC		18-24	4021	Commercial	store			
16N 15W 03 ABBCD	1984	Y	1000	Concrete	1.3	50 lin-2 laterals		28	4022	Commercial	metal shop			
16N 15W 03 ABBCD	1994		1000	Concrete		160' Linear			4023	Household	house	3 Bedrooms		
16N 15W 03 ABBCD	1994	Y				6'ring seep pit			4022	Commercial	store, gas sta	2 Bedrooms		
16N 15W 03 ABCAB	1994		1000	Concrete		200' Linear			4021	Commercial	store, gas sta			
16N 15W 03 ABCB	1993		1000	Concrete		2-60' Laterals		24-36	4018	Commercial	store			
16N 15W 03 ABCBC	1977		1000	Concrete	2	2-3 Ring Pits			4010	Com. & HH	business, house	1		
16N 15W 03 ABCCD	1987	Y	1000	Concrete	0.7	7' Seepage Pit		18	4010	Household	1	3 Bedrooms	200+ lake	
16N 15W 03 ABCDC	1977		1000	Concrete	3	200' Linear PVC		4'	4014	Household	1	2 Bedrooms		
16N 15W 03 ABCDC	1996		1000	Concrete	1.5	100 lin-3 laterals		30	4014	Household	garage			
16N 15W 03 ABCDD	1991	Y	1000	Concrete	3.1	150 lin-4 laterals		18-36	4015	Household	1	2 Bedrooms	100 lake	
16N 15W 03 ABDAA	1984		500	Plastic	1	150' Linear PVC		30-32	4031	Household	1	2 Bedrooms		
16N 15W 03 ABDBC	1987		1000			100' Linear			4025	Commercial	Post Office			
16N 15W 03 ABDCC	1994		1000	Concrete	1.7	3-50' Laterals		36	4030	Household	1	3 Bedrooms		May have turned commercial.
16N 15W 03 ACABB									4010	Com. & HH	Dentist off/house	1		
16N 15W 03 ACACA	1996		1500	Concrete		100' graveless pipe			4010	Com. & HH	1	2 Bedrooms		80' from Tank to Lake
16N 15W 03 ACACC	1986		1000	Concrete	1.5	1-100' Lateral		36	4020	Commercial	Restrooms			2nd septic tank may have been added for RV dump site
16N 15W 03 ACACC	1989	Y		Metal		2-3x6' Rings		24	4020	Commercial	Restaurant		100+ lake	
16N 15W 03 ACADA	1979		1000	Concrete	1	160 lin-3 laterals		18-24	4042	Household	1	3 Bedrooms		
16N 15W 03 ACADD	1991	Y	1000	Concrete		150 lin-4 laterals		24	4042	Commercial	Office		100+	
16N 15W 03 ACCAB	1978		1000	Concrete	1	2-70' Laterals		30+	4010	Household	1	2 Bedrooms		
16N 15W 03 ACCAD	50's-60's					Cess Pool			4002	Household	1	2	125 lake	
16N 15W 03 ACCB	1978		1000	Concrete		150' Linear PVC		30+	4010	Household	1	2 Bedrooms		There are two tanks for the same date replaced.
16N 15W 03 ACCBA	1987	Y	1000	Concrete	1	6' Ring		18	4010	Household	1	2 Bedrooms	100+	
16N 15W 03 ACCBC	1991	Y	1000	Concrete	4	3-50' Laterals		24-36	4010	Household	1	2 Bedrooms		
16N 15W 03 ADAAA	1993		1000	Concrete	1.5	150 lin-2 laterals		18-24	4100	Household	1	3 Bedrooms		50' from Lake to Tank
16N 15W 03 ADAAC	1995		1500	Concrete	1.5	3-50' Laterals		24-36	4080	Household	1	2 Bedrooms		
16N 15W 03 ADABA	1986		1000	Concrete	2	3-50' Laterals		24	4068	Household	1	3 Bedrooms		
16N 15W 03 ADABBB	1987		1000	Concrete	1	3-50' Laterals		18-24	4067	Household	1	3 Bedrooms		

Seeley Lake septic tanks

Location	Date installed	Replace?	Size of tank (gal)	Material made of	Depth to top of tank (ft)	Length of drain field (ft)	Width of trench (ft)	Depth of Drain Field (ft)	Elevation (ft)	Purpose of tank	No. households/businesses served	No. people served	Distance from nearest well (ft)	Remarks
16N 15W 03 ADABC	1986		1500	Concrete	1	4-50' Laterals	24-36	4067	Household	1	3 Bedrooms			
16N 15W 03 ADABD	1985		1000	Concrete	1	3-50' Laterals	24	4074	Household	1	3 Bedrooms			
16N 15W 03 ADACA	1986		1000	Concrete	1	2-75' Laterals	18	4072	Household	1	2 Bedrooms			
16N 15W 03 ADACB	1992		1000	Concrete	1	150' Linear		4064	Household	1	3 Bedrooms			
16N 15W 03 ADACBA	1985		1000	Concrete	1.2	3-50' Laterals	24	4065	Commercial	Store				
16N 15W 03 ADACC	1982		1000	Metal		2-100' Laterals		4064	Household	1	3 Bedrooms			
16N 15W 03 ADACDB	1985		1000	Concrete	1.5	3-50' Laterals	36	4072	Household	1	3 Bedrooms			
16N 15W 03 ADACDC	1992		1000	Concrete	1	2-75' Laterals	30	4072	Household	1	3 Bedrooms			
16N 15W 03 ADADA	1990		1000	Concrete	1	150 lin-3 laterals	24	4079	Household	1	3 Bedrooms			
16N 15W 03 ADADB	1975		1000	Concrete		150' Linear		4076	Household	1	2 Bedrooms			
16N 15W 03 ADADC	1979		1000	Concrete	1	150' Linear PVC	18-24	4072	Household	1	2 Bedrooms			
16N 15W 03 ADADCC	1997		1000	Concrete		150' Linear		4072	Household	1	2 Bedrooms			
16N 15W 03 ADADD	1979		1000	Concrete		200' Linear		4078	Household	1	3 Bedrooms			
16N 15W 03 ADBAAA	1990		1500	Concrete	1	300 lin-5 laterals	24	4060	Household	1	3 Bedrooms			
16N 15W 03 ADBAAB	1993	Y	1000	Concrete		180 lin-3 laterals		4053	Household	Duplex	2-1 Bedroom			
16N 15W 03 ADBAB	1993		1000	Concrete		180 lin-3 laterals		4051	Household	Duplex	2-1 Bedroom			
16N 15W 03 ADBAC	1995		1000	Concrete	1	2-75' Laterals	36	4051	Household	1	2 Bedrooms			
16N 15W 03 ADABC	1996		1500	Concrete	1	5-40' Laterals	36	4053	Household	1	3 Bedrooms			
16N 15W 03 ADADA	1985		1000	Concrete	1	176' Linear PVC	26	4060	Household	1	3 Bedrooms			
16N 15W 03 ADBBAA	1977		1000	Concrete	3	200' Linear PVC	30+	4050	Household	1	3 Bedrooms			
16N 15W 03 ADBBAB	1988		1000	Concrete	1	2-65' Laterals	24	4046	Household	1	2 Bedrooms			
16N 15W 03 ADBBB	1975		1000	Concrete		200' Linear		4040	Household	1	3 Bedrooms			
16N 15W 03 ADBBC	1974		1000	Concrete		150' Linear PVC		4044	Household	1	3 Bedrooms			
16N 15W 03 ADBCA	1986		1000	Concrete	1	3-50' Laterals	24	4051	Household	1	3 Bedrooms			
16N 15W 03 ADBCAD	1986		1000	Concrete	1	2-70' Laterals	24	4051	Household	1	3 Bedrooms			
16N 15W 03 ADBC	1991		1000	Concrete		3-50' Laterals	24	4047	Commercial	Senior center			100+	
16N 15W 03 ADBCCA	1987		1000	Concrete	1	3-50' Laterals	36	4049	Household	1	3 Bedrooms			
16N 15W 03 ADBCDD	1984	Y	1000	Concrete	1	150' Linear PVC	24	4051	Household	1	2 Bedrooms			
16N 15W 03 ADBDA	1981		1000	Concrete	1.3	200' Linear PVC	18-24	4059	Household	1	3-4 Bedrooms			
16N 15W 03 ADBDB	1980		1000	Concrete	1	200 lin-3 laterals	18-24	4055	Household	1	3 Bedrooms			
16N 15W 03 ADBDC	1979		1000	Concrete	1	2-90' Laterals	18	4055	Household	1	2 Bedrooms			
16N 15W 03 ADBDD	1974		1000	Concrete		6 Ring Pit		4060	Household	1	3 Bedrooms			
16N 15W 03 ADCAA	1995		1000	Concrete	1	2-75' Laterals	30	4060	Household	1	2 Bedrooms			
16N 15W 03 ADCAC	1984		1000	Concrete	1.5	150' Linear PVC	18-24	4048	Household	1	3 Bedrooms			
16N 15W 03 ADCACC	1990		1000	Concrete	0.5	3-50' Laterals	30-24	4048	Household	1	3 Bedrooms			
16N 15W 03 ADCAD	1994	Y	1000	Concrete	0.5	6 Rings	12	4049	Household	1	3 Bedrooms			
16N 15W 03 ADCBD	1985		1000	Concrete	1	3-50' Laterals	24-30	4047	Household	1	3 Bedrooms			
16N 15W 03 ADCBDD	1978		1000	Concrete	1	2-70' Laterals	18	4047	Household	1	2 Bedrooms			
16N 15W 03 ADCCAA	1979	Y	1000	Concrete	1	150' Linear	24	4047	Household	1	2 Bedrooms			
16N 15W 03 ADCCAA	1996		1000	Concrete	1.5	3-50' Laterals	18-24	4047	Household	1	2 Bedrooms			
16N 15W 03 ADCCAD	1979		1000	Concrete	1	130 lin 2 laterals	24	4047	Household	1	2 Bedrooms			
16N 15W 03 ADCCB	1988		1500	Concrete	0.8	150' Linear	18-24	4046	Commercial	1 Garage				
16N 15W 03 ADCCB	1985		1000	Concrete		150' Linear		4046	Household	1				
16N 15W 03 ADCCC	1985		1000	Concrete	1.5-2	1-100' Lateral	18-24	4046	Commercial	auto shop				
16N 15W 03 ADCDB	1994		1000	Concrete		3-50' Laterals		4048	Household	1	3 Bedrooms			

Seeley Lake septic tanks

Location	Date installed	Replace?	Size of tank (gal)	Material made of	Depth to top of tank (ft)	Length of drain field (ft)	Width of trench (ft)	Depth of Drain Field (ft)	Elevation (ft)	Purpose of tank	No. households/businesses served	No. people served	Distance from nearest well (ft)	Remarks
16N 15W 03 ADCDC	1985		1000	Concrete	1	3-63.3' Laterals		28	4048	Household	1	3 Bedrooms		
16N 15W 03 ADCDDA	1984		1000	Concrete	1	3-40' Laterals		18-24	4049	Household	1	3 Bedrooms		
16N 15W 03 ADDAA	1985		1000	Concrete	1.5	150' Linear PVC		23-26	4071	Household	1	3 Bedrooms		
16N 15W 03 ADDAC	1980		1000	Concrete	1	150' Linear PVC		18-24	4068	Household	1	3 Bedrooms		
16N 15W 03 ADDACC	1987	Y	1000	Concrete		6 Ring Pit			4053	Household	1	3 Bedrooms		
16N 15W 03 ADDADD	1995		1000	Concrete	1.3	2-50' Laterals		30	4055	Household	1	3 Bedrooms		
16N 15W 03 ADDDBA	1983		1000	Concrete	1	3-44' Laterals		24-36	4064	Household	1	2 Bedrooms		
16N 15W 03 ADDDBB	1995	Y	1000	Concrete	1	6' Ring		18	4060	Household	1	3	<100	
16N 15W 03 ADDDCB	1996	Y	1000	Concrete	1	2-3' Rings		18	4050	Household	1	3 Bedrooms	100+	
16N 15W 03 ADDDCC	1971		750	Concrete		100' Linear			4049	Household	1	2 Bedrooms		
16N 15W 03 ADDCDB	1986	Y	1000	Concrete	3	6x6 concr rings		36	4050	Household	1	3 Bedrooms		
16N 15W 03 ADDDA	1979		1000	Concrete	1	200' Linear PVC		18	4055	Household	1	3 Bedrooms		
16N 15W 03 ADDDBB	1995	Y	1000	Concrete	0.7	6'x7' Rings			4053	Household	1	2 Bedrooms		
16N 15W 03 ADDDBC	1978		1000	Concrete	1	200' Linear PVC		24	4053	Household	1	3 Bedrooms		
16N 15W 03 ADDDCC	1975		1000	Concrete		200' Linear PVC			4050	Household	1	3 Bedrooms		
16N 15W 03 BACAA	1991		1000	Concrete		200' Linear			4002	Household	1	3 Bedrooms		
16N 15W 03 BADABB	1983		1000	Concrete	1	200' Linear PVC	14-16	4010	4010	Household	1	3 Bedrooms		
16N 15W 03 BADACC	1984		1000	Concrete	1.5	150' Linear PVC	30	4003	4003	Household	1	3 Bedrooms		
16N 15W 03 BADBBB	1972		1000	Concrete		5 Ring Pit			4003	Household	1	3 Bedrooms		
16N 15W 03 BADBC	1979	Y	500	Metal	1	2-3 Ring Pits			4002	Household	1	2 Bedrooms		
16N 15W 03 BADBC	1957								4005	Household	1	1		
16N 15W 03 BADCC	1979		1000	Metal	1	150 lin-2 laterals			4002	Household	1	2 Bedrooms		
16N 15W 03 BADCD	Late 70's		1000			3 at 65			4002	Household	1	2		Seasonal Use
16N 15W 03 BADDDD	1989	Y	1000	Concrete	1.5	3-45' Laterals			4020	Commercial	bar			
16N 15W 03 BADDDD	1987	Y				148 lin-2 laterals	24-36	4020	4020	Household	1	2 Bedrooms		tank located behind filling station, use not specified
16N 15W 03 BCBBC	1994	Y	1000	Concrete	1	15x30 seep bed	12	4002	4002	Household	1	2 Bedrooms	100 lake	
16N 15W 03 BCBBC	1973		1000	Concrete		200' Linear PVC			4003	Household	1	2 Bedrooms		Water supply is from the lake.
16N 15W 03 BCCBBB	1990	Y	1000	Concrete		200' Linear			4003	Household	1	2 Bedrooms	100+ lake	If trailer added, tank would be 1500 gal. w/ 300' drainfield, not verified
16N 15W 03 BCCDDD	1983		1000	Concrete	1	100 lin-2 laterals	24/30	4003	4003	Household	1	1 Bedroom		
16N 15W 03 BDAAA	1971		1000	Concrete		100' Linear			4002	Household	1	2 Bedrooms		
16N 15W 03 BDAAB	1971								4003	Household	1			Permit missing in the files.
16N 15W 03 BDCDD	1974		1000	Concrete		6 Ring Pit			4002	Household	1	2 Bedrooms		
16N 15W 03 BDDCD	1993		1000	Concrete		170' Linear			4010	Household	1	2		
16N 15W 03 BDDDDC	1993		1000	Concrete	1	180 lin-2 laterals	18-36	4016	4016	Household	1	3 Bedrooms	100 lake	
16N 15W 03 CCBDDC	1992	Y	1000	Concrete	1.5	4-50' Laterals	24	4016	4016	Household	1	3 Bedrooms	200' river	4'x6.5' Concrete Lift Station after the Tank
16N 15W 03 CCBDDC	1997	Y	1000	Concrete		20x30 seep bed			4015	Household	1	2 Bedrooms	100+ river	
16N 15W 03 CCGAAA	1974		1000	Metal		2-3 Ring Pit			4015	Household	1			
16N 15W 03 CCGABB	1996		1000	Concrete	1	Seepage Bed			4014	Household	1	2 Bedrooms	100+ river	
16N 15W 03 CCGABB	1973		750	Metal		2-70' Laterals			4018	Household	1	2 Bedrooms	100+ river	
16N 15W 03 CCGBBB	1983	Y	1000	Concrete	1	160 lin-2 laterals	18-24	4017	4017	Household	1	2 Bedrooms	100+ river	
16N 15W 03 CCGBC	1986		1000	Concrete	1.5	200 lin-3 laterals	24-36	4021	4021	Household	1	3 Bedrooms	100+ river	Gravity Pressured Dosed
16N 15W 03 CCGBC	1972?		900	Concrete		150' Linear			4021	Household	1	3 Bedrooms		
16N 15W 03 CDDAAA	1977		1000	Concrete	1	2-90' Laterals	24	4004	4004	Household	1	3 Bedrooms		
16N 15W 03 CCDACC	1975		1000	Metal		160' Linear	18	4010	4010	Household	1		120' river	

Seeley Lake septic tanks

Location	Date installed	Replace?	Size of tank (gal)	Material made of	Depth to top of tank (ft)	Length of drain field (ft)	Width of trench (ft)	Depth of Drain Field (ft)	Elevation (ft)	Purpose of tank	No. households/businesses served	No. people served	Distance from nearest well (ft)	Remarks
16N 15W 03 CDBCC	1974	Y	1000	Concrete	1	6 ring seep pit		4012	Household	1	2 Bedrooms			Water supply is from the lake.
16N 15W 03 CDGCCA	1985	Y	1000	Concrete	1.2	2-75' Laterals	3	24	4002	Household	1	2 Bedrooms	100+ river	
16N 15W 03 CDCCCC	1984	Y	1000	Concrete	1.5	200 lin-2 laterals		36	4021	Household	1	3 Bedrooms	100+	
16N 15W 03 CCDBBB	1979	Y	1000	Concrete		200' Linear			4002	Household	1	3 Bedrooms		
16N 15W 03 CDCBDD	>1982								4013	Household	1	4-6	30-40	
16N 15W 03 CDCBAB	1977		1000	Concrete	1	2-3 Ring Pits	3		4018	Household	1	1	by aband well	
16N 15W 03 CDCCC	1984	Y	2-1000	Concrete	1.2	615' Linear PVC	30-40	4003	Household	Trailer Court	1	8 Units	100 stream	
16N 15W 03 CDCCCC	1990	Y	1000	Concrete	0.7	2-75' Laterals	24	4004	Household	1	1 Bedroom			
16N 15W 03 CDCDA	1979	Y	1000	Concrete	1	3-50' Laterals	18-24	4016	Household	1	2-3 Bedrooms			
16N 15W 03 CDCA	1980	Y	1000	Concrete	1	2-50' Laterals	18-24	4019	Household	1	2 Bedrooms			
16N 15W 03 CDPCB	1988	Y	1000	Concrete	1	6'x8' Rings	24	4017	Household	1	3 Bedrooms			
16N 15W 03 DAAAA	1983	Y	1000	Concrete	1	6' Ring	18	4065	Household	1	3 Bedrooms			
16N 15W 03 DAAAAAB	1978		1000	Concrete		200' Linear		4063	Household	1	3 Bedrooms			
16N 15W 03 DAAACC	1985		1000	Concrete	1.2	6' concr ring	12-14	4063	Household	1	3 Bedrooms			
16N 15W 03 DAAADC	1988							4065	Household	1				
16N 15W 03 DAACAA	1978		1000	Concrete		150' Linear		4060	Household	1	1 Bedroom			
16N 15W 03 DAACAAA	1978		1000	Concrete		200' Linear		4061	Household	1	3 Bedrooms			
16N 15W 03 DAACCCB	1979		1000	Concrete	1	150' Linear PVC	18-24	4053	Household	1 Trailer				
16N 15W 03 DAACCCC	1980		1000	Concrete		200' Linear		4053	Household	1	2			
16N 15W 03 DAADAD	1976		1000	Concrete	0.5	150' Linear PVC	30	4050	Household	1 Trailer	2			
16N 15W 03 DAADBA	1978		1000	Concrete		150' Linear		4063	Household	1	2 Bedrooms			
16N 15W 03 DAADBD	1983		1000	Plastic	1	3-50' Laterals	30	4063	Household	1	3 Bedrooms	20' lake		
16N 15W 03 DAADDD	1979		1000	Concrete	2		24-30	4064	Household	1	2 Bedrooms			
16N 15W 03 DABAD	1985		1000	Concrete		155' Linear		4051	Household	1	3 Bedrooms			
16N 15W 03 DABBBB	1985	Y	1500	Concrete		300' Linear		4045	Church	church, 2 houses				
16N 15W 03 DABBBB	1978		750	Concrete		100' Linear		4047						
16N 15W 03 DABCAA	1985		1000	Concrete	2	150' Linear PVC	24-36	4049	Household	1	3 Bedrooms			
16N 15W 03 DABCCC	1983		1000	Concrete	1	2-75' Laterals	30	4046	Household	1	3 Bedrooms			was household-may be commercial now
16N 15W 03 DABCCD	1983		1000	Concrete	1	200' Linear PVC	18-24	4049	Household	1	3 Bedrooms			
16N 15W 03 DABDDA	1984		1000	Concrete	1	150' Linear PVC	30-36	4051	Household	1	3 Bedrooms			
16N 15W 03 DABDDD	1984		1000	Concrete	1	150 lin-2 laterals	24	4051	Household	1	3 Bedrooms			
16N 15W 03 DACACC	1982	Y	1000	Concrete		2-100' Laterals	30	4046	Commercial	trailer, business				May have possibly been replaced.
16N 15W 03 DACADD	1983		1000	Concrete	1	150' Linear	24-30	4055	Household	1	3 Bedrooms			This could be commercial now.
16N 15W 03 DACBAA	1978		1000	Concrete		150' Linear		4046	Household	1	2 Bedrooms			
16N 15W 03 DACBDD	1978		1000	Concrete	1	100' Linear PVC	18	4046	Commercial	Office Building				
16N 15W 03 DACDCA	1984		1000	Concrete	0.7	2-75' Laterals	18-24	4050	Commercial	1 Bank				
16N 15W 03 DADBA	1979		1500	Concrete	1.5	3-60' Laterals	24	4060	Church	1			200-250	
16N 15W 03 DADBBB	1985		1000	Concrete		3-45' Laterals	30	4051	Household	1	2 Bedrooms			
16N 15W 03 DADBBCC	1983		1000	Concrete	1	150' Linear	30	4056	Household	1	3 Bedrooms			
16N 15W 03 DADDBA	1984		1000	Concrete	1	2-75' Laterals	24	4056	Household	1	3 Bedrooms			
16N 15W 03 DADCCD	1984		1000	Concrete		150' Linear		4055	Household	1	3 Bedrooms			
16N 15W 03 DBCD	1948-7/		3-1000, 1-500			dry wells		4025	Industrial	1				
16N 15W 03 DCCCAA	1977	Y	1000			2-3 Ring Pits		4021	Household	1	3 Bedrooms			
16N 15W 03 DCCCBA	1978		1000	Concrete		200' Linear		4021	Household	1	3 Bedrooms			
16N 15W 03 DCCDBB	1987		1000	Concrete	1.3	150 lin-4 laterals	36	4021	Household	1	2 Bedrooms			

Seeley Lake septic tanks

Location	Date installed	Replace?	Size of tank (gal)	Material made of	Depth to top of tank (ft)	Length of drain field (ft)	Width of trench (ft)	Depth of Drain Field (ft)	Elevation (ft)	Purpose of tank	No. households/businesses served	No. people served	Distance from nearest well (ft)	Remarks
16N 15W 03 DCDABC	1989		1000	Concrete	1	150' lin-2 lat-pit	26-36	4021	Household	1	2 Bedrooms		Pit is 6 feet high.	
16N 15W 03 DCDBAD	1990	Y	1000	Concrete	3	3-50' Laterals	30	4021	Household	1	2 Bedrooms		These could be 1 septic tank, thought there were 2 locations	
16N 15W 03 DDABBB	1991		1000	Concrete		200' Linear		4055	Household	1	3 Bedrooms			
16N 15W 03 DDABCB	1987		1000	Concrete		200' Linear		4050	Household	1	1	100+/-		
16N 15W 03 DDABCA	1986		1000	Concrete		200' Linear		4045	Com. & HH	gas sta. apart	2-3 Employees	200+/-		
16N 15W 04 AACBC	1994		1000	Plastic	1	2-75' Laterals	12	4004	Household	1	2 Bedrooms			
16N 15W 04 ABABA	1988	Y	1000	Concrete	1.5	187 lin-2 laterals	24	4002	Household	1	3 Bedrooms	100+		
16N 15W 04 ABABB	1994		1000	Concrete		150' Linear		4002	Household	1	2 Bedrooms			
16N 15W 04 ADACC	1988		1000	Concrete	0.8	150 lin-2 laterals	18-36	4000	Household	1	2 Bedrooms			
16N 15W 04 ABBCD	1983	Y	1000	Concrete	1	200' Linear PVC	14-16	4002	Household	1	2 Bedrooms	100		
16N 15W 04 ABDD	1992	Y	1000	Concrete	0.7	2-75' Laterals	24	4000	Household	1	2 Bedrooms			
16N 15W 04 ADDBA	1990		1000	Concrete	1	3x40' Mound	12	4001	Household	1	2 Bedrooms	100		
16N 15W 04 BBBCD	1990		1100	Concrete	1	2-75' Laterals	30	4000	Household	1	2 Bedrooms	100+	110' to River. 400 Gallon Pump Station after Tank.	
16N 15W 04 BCBAD	1994	Y	1500	Concrete	2	3-50' Laterals	24-36	4000	Household	1	2 Bedrooms	100		
16N 15W 04 BCDA	1995	Y	1000	Concrete		240' Linear	18	4000	Household	1	3 Bedrooms	100+		
16N 15W 04 CADAA	1994		1000	Concrete	1	3-50' Laterals	36	3998	Household	1	2 Bedrooms	100		
16N 15W 04 CADCC	1994	Y	1000	Concrete	1.5	3-50' Laterals	24	3998	Household	1	2 Bedrooms	100		
16N 15W 04 CDAAA	1994		1000	Concrete	2	3-50' Laterals	30	3998	Household	1	2 Bedrooms	100		
16N 15W 04 DBDCB	1989	Y	1000	Concrete	ground	150 lin-2 laterals	18-24	3997	Household	1	2 Bedrooms	100+ river		
16N 15W 05 AAAAD	1996	Y	1000	Concrete	1.5	2-75' Laterals	24	4001	Household	1	2 Bedrooms	100		
16N 15W 05 ACC	1995		1000	Concrete	1.3	250 lin-4 laterals	30	4119	Household	1	4 Bedrooms	160		
16N 15W 05 BADD	1995		1500	Concrete	1	375 lin-6 laterals	24	4142	Household	1	4 Bedrooms			
16N 15W 05 BDB	1995		1000	Concrete				4197	Unknown			100+		
16N 15W 05 CAA	1995		1000	Concrete				4221	Unknown			100+		
16N 15W 05 DBCC	1995		1000	Concrete				4240	Unknown			100+		
16N 15W 10 AACA	1995		1500	Concrete		250 lin-3 laterals		4017	Commercial	10 Offices				
16N 15W 10 ACCCC	1995	Y	1000	Concrete				4020	Household	1	2 Bedrooms	100+		
16N 15W 10 ACDDD	1996		1000	Concrete	1.5	3-100' Laterals	30	4030	Commercial	1	4 Bedrooms	100+	10+ to Surface Water	
16N 15W 10 BAABA	1983	Y	1000	Concrete	1	6' Ring Pit		4019	Household	1	1 Bedroom			
16N 15W 10 BAACD	1991	Y	1000	Fiberglass	1	5-50' Laterals		4024	Household	1	3 Bedrooms			
16N 15W 10 BAADBA	1995		500	Concrete	1.5	3 at 60		4022	Household	1	2	100+		
16N 15W 10 BABAC	1996	Y	1000	Concrete	1	3-50' Laterals	24	4023	Household	1	2 Bedrooms			
16N 15W 10 BABDB	1996	Y	1000	Concrete	1.5	3-50' Laterals	24-36	4022	Household	1	2 Bedrooms			
16N 15W 10 BABDC	1989		1000	Concrete	1.25	2-75' Laterals	36	4021	Household	1	2 Bedrooms			
16N 15W 10 BABDD	1993	Y	750	Concrete		150' Linear		4026	Household	1	2 Bedrooms			
16N 15W 10 BACCA	1980	Y	1000	Concrete	1	165 lin-2 laterals	18-24	4020	Household	1	3 Bedrooms			
16N 15W 10 BACCD	1985	Y	1000	Steel	1.2	215' Linear PVC	30	4020	Household	1	3 Bedrooms			
16N 15W 10 BACDD	1990	Y	1000	Concrete	1	2-75' Laterals	30	4007	Household	1	2 Bedrooms	100	100+ to River	
16N 15W 10 BADA	1984		1000	Concrete	-8-1	190' Linear PVC	24	4023	Household	1	3 Bedrooms	100		
16N 15W 10 BADDD	1973		1000	Concrete		2-75' Laterals		4010	Household	1	2 Bedrooms	100+		
16N 15W 10 BBABD	1992		1000	Concrete	1.5	195 lin-2 laterals	24	4004	Household	1	2 Bedrooms	100	100+ to River. 540 Gallon Lift Station after Tank.	
16N 15W 10 BBCAA	1994	Y	1000	Concrete	1	2-75' Laterals	30	4007	Household	1	2 Bedrooms	100 river		

Seeley Lake septic tanks

Location	Date installed	Replace?	Size of tank (gal)	Material made of	Depth to top of tank (ft)	Length of drain field (ft)	Width of trench (ft)	Depth of Drain Field (ft)	Elevation (ft)	Purpose of tank	No. households/businesses served	No. people served	Distance from nearest well (ft)	Remarks
16N 15W 10 BBCAD	1991	Y	1000	Concrete	0.7	3-50' Laterals		30	4007	Household	1	2 Bedrooms	100 river	
16N 15W 10 BCAAA	1990	Y	1000	Concrete	1	2-90' Laterals		24	4010	Household	1	3 Bedrooms	100 river	Second Trailer
16N 15W 10 BCAAA	1990	Y	1000	Concrete	1	2-90' Laterals		24	4010	Household	1	3 Bedrooms	100 river	First Trailer
16N 15W 10 BCAAD	1995	Y	1000	Concrete	1	150' Linear			4010	Household	1	2 Bedrooms	100 river	
16N 15W 10 BCACC	1992		1000	Concrete	1	4-50' Laterals		30	4021	Household	1	2 Bedrooms	115 river	
16N 15W 10 BCADC	1983	Y	1000	Concrete	1.5	150' Linear PVC		24	4001	Household	1	1 Bedroom	100'	
16N 15W 10 BCBAD	1988	Y	1000	Concrete	1.3	200 lin-2 laterals		30	4021	Household	1	3 Bedrooms	100 river	
16N 15W 10 BCBBD	1991	Y	1000	Concrete	1.5	190' Linear		24-36	4017	Household	1	3 Bedrooms		
16N 15W 10 BDBDA	1985	Y	1000	Steel	1-1.2	150' Linear PVC		24	4000	Household	1	2 Bedrooms		
16N 15W 10 BDDBB	1984	Y	1000	Concrete	1	2-70' Laterals		24-30	3998	Household	1	2 Bedrooms		
16N 15W 10 BDDDD	1996	Y	1000	Concrete	1	150' Linear			4010	Household	1	2 Bedrooms	100+	
16N 15W 10 DACDD	1984		1000	Concrete	1.5	2-70' Laterals		18-24	4040	Household	1	2 Bedrooms		
16N 15W 10 DADB	1989		1000	Concrete	1.3	3-80' Laterals		30	4000	Household	1	4 Bedrooms		
16N 15W 10 DBACC	1984		1000	Concrete	1.5-2	125' Linear PVC		24-36	3998	Household	1	2 Bedrooms	120' river	
16N 15W 10 DBCCC	1993		1000	Concrete	1.5	190 lin-3 laterals		24	3996	Household	house, garage	3 Bedrooms	100+ river	
16N 15W 10 DBCCDD	1992		1000	Concrete	1.5	3-50' Laterals		26	3997	Household	1	2 Bedrooms	100+ river	
16N 15W 10 DBCCD	1992		1000	Concrete	1	150 lin-2 laterals		24	3998	Household	1	2 Bedrooms	100	
16N 15W 10 DBCDD	1988		1000	Concrete	1.5	3-63' Laterals		30	4000	Household	1	3 Bedrooms	100' river	100' to River
16N 15W 10 DBDCB	1978		1000	Metal	1.5	2-65' Laterals PVC		24	4020	Household	1	2 Bedrooms		
16N 15W 10 DCADD	1993		1000	Concrete	1.5	190 lin-2 laterals		36-24	4030	Household	1	3 Bedrooms		
16N 15W 10 DCBAA	1990		1000	Fiberglass	1	3-63' Laterals		28	4000	Household	1	3 Bedrooms		
16N 15W 10 DCBAB	1984		1000	Concrete	1.5-2	150' Linear PVC		18-36	3998	Household	1	2 Bedrooms	200+ stream	
16N 15W 10 DCBDB	1986		1000	Concrete	0.7	4-40' Laterals		24	3998	Household	1	2 Bedrooms		
16N 15W 10 DCBDD	1992		1000	Concrete	1	150 lin-2 laterals		24	3998	Household	1	2 Bedrooms	100+ river	
16N 15W 10 DDBCA	1995		1000	Concrete	1.5	2-65' Laterals		30	4025	Household	1	2 Bedrooms	6+ stream	
16N 15W 10 DDBCB	1979		1000	Concrete	1	160' Linear			4025	Household	1	2 Bedrooms		
16N 15W 10 DDD	1983		1000	Concrete	1	200' Linear			3660	Household	1	3 Bedrooms		
16N 15W 11 AAAAA	1980		1000	Concrete	1	200 lin-4 laterals		18-24	4140	Household	1	2 Bedrooms		
16N 15W 11 AAABB	1988		1000	Concrete	2	3-63' Laterals		30	4140	Household	1	3 Bedrooms	100+	
16N 15W 11 AAACB	1994		1000	Concrete	0.8	3-50' Laterals		18	4108	Household	1	2 Bedrooms	100+	
16N 15W 11 AABBD	1992		1000	Concrete	1	150' Linear			4140	Household	1	2 Bedrooms		
16N 15W 11 AACAB	1995		1500	Concrete	1.5	3-50' Laterals		30	4120	Household	1	2 Bedrooms	100+	6+ to Stream
16N 15W 11 AACDA	1994		1000	Concrete	2	3-75' Laterals		30	4121	Household	1	3 Bedrooms	200	
16N 15W 11 ABAAC	1986		1000	Concrete	1.5	3-70' Laterals		24	4200	Household	1	3 Bedrooms	100+	
16N 15W 11 ABBDD	1988		1000	Concrete	1.5	2-75' Laterals		30	4080	Household	1	2 Bedrooms	160	
16N 15W 11 ABCAA	1988		1000	Concrete	1.5	3-63' Laterals		30	4075	Household	1	3 Bedrooms	100+	
16N 15W 11 ABCBD	1992		1000	Concrete	1	150' Linear			4102	Household	1	2 Bedrooms		
16N 15W 11 ABDCC	1996		1000	Concrete	1	3-55' Laterals		24	4081	Household	1	2 Bedrooms		
16N 15W 11 ACACC	1980		1000	Concrete	1	175 lin-3 laterals		18-24	4045	Household	1	3 Bedrooms		
16N 15W 11 ACBCB	1994		1000	Concrete	1	3-75' Laterals		24	4043	Household	1	3 Bedrooms		
16N 15W 11 ACCCA	1993		1000	Concrete	1	150' Linear			4020	Household	1	2 Bedrooms	100+	
16N 15W 11 ACDBB	1978		1000	Concrete	1	200' Linear PVC			4040	Household	1	2 Bedrooms		
16N 15W 11 ADACD	1980		1000	Concrete	1	150' Linear PVC		18-24	4046	Household	1	2 Bedrooms		
16N 15W 11 ADBCC	1986		1000	Concrete	1	3-50' Laterals		30	4060	Household	1	2 Bedrooms	100+	

Seeley Lake septic tanks

Location	Date installed	Replace?	Size of tank (gal)	Material made of	Depth to top of tank (ft)	Length of drain field (ft)	Width of trench (ft)	Depth of Drain Field (ft)	Elevation (ft)	Purpose of tank	No. households/businesses served	No. people served	Distance from nearest well (ft)	Remarks
16N 15W 11 ADCDD	1989		1000		24/-	250		30	4065	Household	1	4	100+	70'-80' from Tank to Well
16N 15W 11 ADDCC	1992	Y	1000	Concrete	1	3-30' Laterals		30	4046	Household	1	2 Bedrooms	100+	
16N 15W 11 BACCC	1995		1000	Concrete	1	3 Laterals		30	4020	Household	1	3 Bedrooms	100	
16N 15W 11 BADBC	1991		1000	Concrete	1	3-70' Laterals		30	4039	Household	1	2 Bedrooms	100+	
16N 15W 11 BADCB	1995		1000	Concrete	1	160 lin-3 laterals		28	4035	Household	1	2 Bedrooms		
16N 15W 11 BADDA	1997		1000	Concrete	1	4-60' Laterals		28	4060	Household	1	3 Bedrooms		
16N 15W 11 BADD	1997		1000	Concrete	1	150' Linear		36	4054	Household	1	2 Bedrooms	100+	
16N 15W 11 BBABD	1989		1000	Concrete	1	190 lin-3 laterals		36	4030	Household	1	3 Bedrooms		
16N 15W 11 BBBCA	1977		1000	Concrete	1	3-70' Laterals		18-24	4037	Household	1	3 Bedrooms		
16N 15W 11 BBBCA	1978		1000	Concrete	1-2	160' Linear		24	4037	Household	1	2		
16N 15W 11 BBBDD	1978		1000	Concrete	2	160' Linear		18	4037	Household	1	2 Bedrooms		
16N 15W 11 BBCAC	1977		1000	Metal	2	200' Linear PVC		18-36	4032	Household	1	2 Bedrooms		
16N 15W 11 BBCDA	1985		1000	Concrete	2	3-60' Laterals		18-36	4031	Household	1	2 Bedrooms		
16N 15W 11 BBDBD	1978		1000	Concrete	1.5	240' Linear PVC		24	4034	Household	1	3 Bedrooms		
16N 15W 11 BBDCDA	1994		1000	Concrete	1.5	155 lin-2 laterals		24	4032	Household	1	2 Bedrooms		
16N 15W 11 BCBAA	1974		1000	Concrete	2.5	200' Linear PVC		36	4026	Household	1			
16N 15W 11 BCBCA	1995	Y	1000	Concrete	2	200 lin-3 laterals		36	4021	Commercial	grocery store			
16N 15W 11 BCBCC	1985		2-1500	Concrete	2	12-75' Laterals		24-30	4020	Commercial	1 Hotel	21 Rooms		
16N 15W 11 BDAAD	1994		1000	Concrete	1.5	3-75' Laterals		36	4024	Household	1	3 Bedrooms	100	
16N 15W 11 BDABC	1974		1000	Fiberglass	1	150 lin-PVC, cast iron		36	4023	Household	1	2 Bedrooms		
16N 15W 11 BDADD	1995		1000	Concrete	1	3-75' Laterals		24	4021	Household	1	3 Bedrooms		possible 2nd tank for double wide pulled off in the 70's
16N 15W 11 BDDBA	1980		1500	Concrete	1	300' Linear PVC		18-24	4021	Household	1	4 Bedrooms		
16N 15W 11 BDBDC	1982		1000	Concrete	1	200' Linear PVC		18-24	4019	Household	1	3 Bedrooms		
16N 15W 11 BDDCC	1981		1000	Concrete	1	225' Linear		18-24	3998	Household	1	2 Bedrooms	100	
16N 15W 11 BDDDC	1979		1000	Concrete	1	190 lin-2 laterals		24	3999	Household	1	3 Bedrooms		
16N 15W 11 CABAA	1978		1000	Concrete	1	300' Linear		24	3997	Household	1	4 Bedrooms		
16N 15W 11 CABDA	1991		1000	Concrete	1	3-50' Laterals		30	3995	Household	1	2 Bedrooms	100	100' to Stream
16N 15W 11 CADAB	1978		1000	Concrete	1	200' Linear PVC		18-24	4000	Household	1	3 Bedrooms		
16N 15W 11 CADAC	1982		1000	Concrete	1	254' Linear PVC		30	4000	Household	1	2 Bedrooms	200	100' to Stream
16N 15W 11 CADBB	1978		1000	Concrete	2	225' Linear		36	3998	Household	1	3 Bedrooms	100	
16N 15W 11 CADDC	1994		1000	Concrete	1.3	2-75' Laterals		24	4003	Household	1	3 Bedrooms	100	
16N 15W 11 CBACA	1989		1000	Concrete	1.5	150 lin-2 laterals		24	4048	Household	1	2 Bedrooms	110	100' to Stream
16N 15W 11 CDABA	1992		1000	Concrete	0.7	3-100' Laterals		24	4020	Household	1	4 Bedrooms	100	100+ to Stream
16N 15W 11 DAAAA	1995		1000	Concrete	2	220 lin-3 laterals		24	4007	Commercial	4 Plex Motel			
16N 15W 11 DB	1985		1000	Concrete	3	6 Ring Pit		24	4000	Commercial	house, 2 cabins	4 Bedrooms		
16N 15W 11 DBAAD	1992		1000	Concrete	2	300 lin-4 laterals		24	4007	Commercial	Main Lodge	1 Kitchen, 3 Bd		
16N 15W 11 DCBD	1995	Y	1500	Concrete	3	240' Linear		24	4000	Commercial	Meeting Facility	12 Bedrooms		Community Septic System was all the permit said.
16N 15W 11 DCDD	1997		1000	Concrete	0.8	200 lin-4 laterals		24	4041	Commercial	Triplex			
16N 15W 11 DCDA	1981		1000	Concrete	0.8	200 lin-4 laterals		24	4041	Commercial				
16N 15W 11 DDCA	1990	Y	1000	Concrete	0.8	200 lin-4 laterals		24	4041	Commercial				

Seeley Lake septic tanks

Location	Date installed	Replace?	Size of tank (gal)	Material made of	Depth to top of tank (ft)	Length of drain field (ft)	Width of trench (ft)	Depth of Drain Field (ft)	Elevation (ft)	Purpose of tank	No. households/businesses served	No. people served	Distance from nearest well (ft)	Remarks
16N 15W 12 AAAA	1992		1000	Concrete	1	3-30 lin-4 laterals	24	4243		Household	1		100+	
16N 15W 12 AACCA								4217		Household	1			
16N 15W 12 AACCD	1991		1000	Concrete	2	230 lin-3 laterals	18-36	4217		Household	1	2 Bedrooms	100 to D.F.	50' to Tank
16N 15W 12 AADDC	1986		1000	Concrete	5	3-50' Laterals	48	4250		Household	1	2 Bedrooms	100+	
16N 15W 12 ABCCC	1995		1000	Concrete	1	190 lin-3 laterals	36	4160		Household	1	2 Bedrooms	100	
16N 15W 12 ACBBA	1993	Y	1000	Fiberglass	1	3-63' Laterals	24	4160		Household	1	2 Bedrooms		
16N 15W 12 ACCDB	1980		1500	Concrete	1	300' Linear PVC	18-24	4198		Household	Bunkhouse			
16N 15W 12 ADBCD								4225		Household	1			Permit missing in files.
16N 15W 12 ADCCC	1995	Y	1000	Concrete		3-90' Laterals		4200		Household	1	3 Bedrooms	50+ to Tank	
16N 15W 12 BADCC	1982		1000	Concrete	1	200' Linear PVC	18-24	4139		Household	1	3 Bedrooms		
16N 15W 12 BADDD	1996		1000	Concrete	1	2-75' Laterals	24-36	4140		Household	1	2 Bedrooms	100	
16N 15W 12 BBBBD	1980		1000	Concrete	1	150' Linear PVC	18-24	4100		Household	1	2		
16N 15W 12 BBCEB	1986	Y	1000	Concrete		150' Linear	2	4100		Household	1	2 Bedrooms	100	
16N 15W 12 BECCC	1978		1000	Concrete	1	200' Linear PVC	18	4098		Household	1	3 Bedrooms		
16N 15W 12 BBCCD	1993		1000	Concrete		150' Linear		4098		Household	1	2 Bedrooms		
16N 15W 12 BBDBB	1993		1000	Concrete	1	230 lin-4 laterals	36	4098		Household	1	3 Bedrooms	100	
16N 15W 12 BBDBC	1984		1000	Concrete	1	200' Linear PVC	24-28	4098		Household	1	2 Bedrooms		
16N 15W 12 BCAC	1980		1000	Concrete	1	150' Linear PVC	18-24	4077		Household	1	2 Bedrooms		
16N 15W 12 BCBC	1994		1000	Concrete	1	160 lin-3 laterals	24-36	4067		Household	1	2 Bedrooms	100	
16N 15W 12 BCBB	1990		1000	Concrete	2	3-50' Laterals	24-36	4070		Household	1	2 Bedrooms	100 stream	
16N 15W 12 BCCDD	1994		1000	Concrete	1.5	225 lin-3 laterals	24-36	4082		Household	1	3 Bedrooms	100	10+ to Stream
16N 15W 12 BCDA	1990		1000	Concrete	1.5	3-75' Laterals	24	4115		Household	1	3 Bedrooms	110	
16N 15W 12 BDAAB	1983		1000	Steel	1	200' Linear PVC	24-30	4130		Household	1	2 Bedrooms	160	
16N 15W 12 BDBBB	1980		1000	Concrete	1	100' Linear PVC	18-24	4085		Household	1	1 Bedroom		
16N 15W 12 BDCCC	1981		1000	Concrete	1.5	3-40' Laterals	24	4120		Household	1	2 Bedrooms		
16N 15W 12 BDDAA	1995		1000	Concrete	1.5	190 lin-4 laterals	24	4163		Household	1	2 Bedrooms	160	
16N 15W 12 CAAAA	1995		1000	Concrete		190' Linear		4162		Household	1	2 Bedrooms	100+	
16N 15W 12 CABD	1988		1000	Concrete	1	200 lin-4 laterals		4117		Household	1	2 Bedrooms	100	
16N 15W 12 CADA	1997		1000	Concrete	1	3-50' Laterals	24	4162		Household	1	2 Bedrooms	100+	
16N 15W 12 CBCAA	1979		1000	Concrete		150' Linear		4086		Household	1	2 Bedrooms		
16N 15W 12 CBDAA	1996		1000	Concrete		225' Linear		4090		Household	1	3 Bedrooms	100+	
16N 15W 12 CCADC	1992		1000	Concrete	1	210 lin-3 laterals	24	4165		Household	1	3 Bedrooms	100	
16N 15W 12 CCBAD	1980		1000	Concrete	1	165 Linear PVC	18-24	4160		Household	1	2 Bedrooms		
16N 15W 12 CCDDD	1994		1000	Concrete		2-75' Laterals		4200		Household	1	2 Bedrooms		
16N 15W 14 AADDC	1988		1000	Concrete	1.7	157 lin-3 laterals	18-36	4061		Household	1	3 Bedrooms	100	
16N 15W 14 ACBA	1995		1000	Concrete		370' Linear Feet		4059		Household	1	3 Bedrooms	100+	
16N 15W 14 ACBBC	1995		3-1000	Concrete		3-100' Laterals	30	3967		Government	2 bldgs w/ fir dims			Oil & Sand Separators Attached to Each Building.
16N 15W 14 ACCCC	1996	Y	1000	Concrete	2	3-50' Laterals	24	3962		Household	1	2 Bedrooms	100+	100+ to River
16N 15W 14 BAC	1992		1000	Concrete	0.9	2-80' Laterals	26	3962		Household	1	2 Bedrooms	100+	10+ to River
16N 15W 14 BBA	1987		1000	Concrete	1	225 lin-3 laterals	36	3965		Household	1	2 Bedrooms	100+ S.W.	
16N 15W 14 BDBC	1984		1000	Concrete	-7-1	3-70' Laterals	24	4000		Household	1	3 Bedrooms	100+	
16N 15W 14 CAA	1994		1000	Concrete	1	190 lin-3 laterals	18-24	3958		Household	1	3 Bedrooms	100+	

Seeley Lake septic tanks



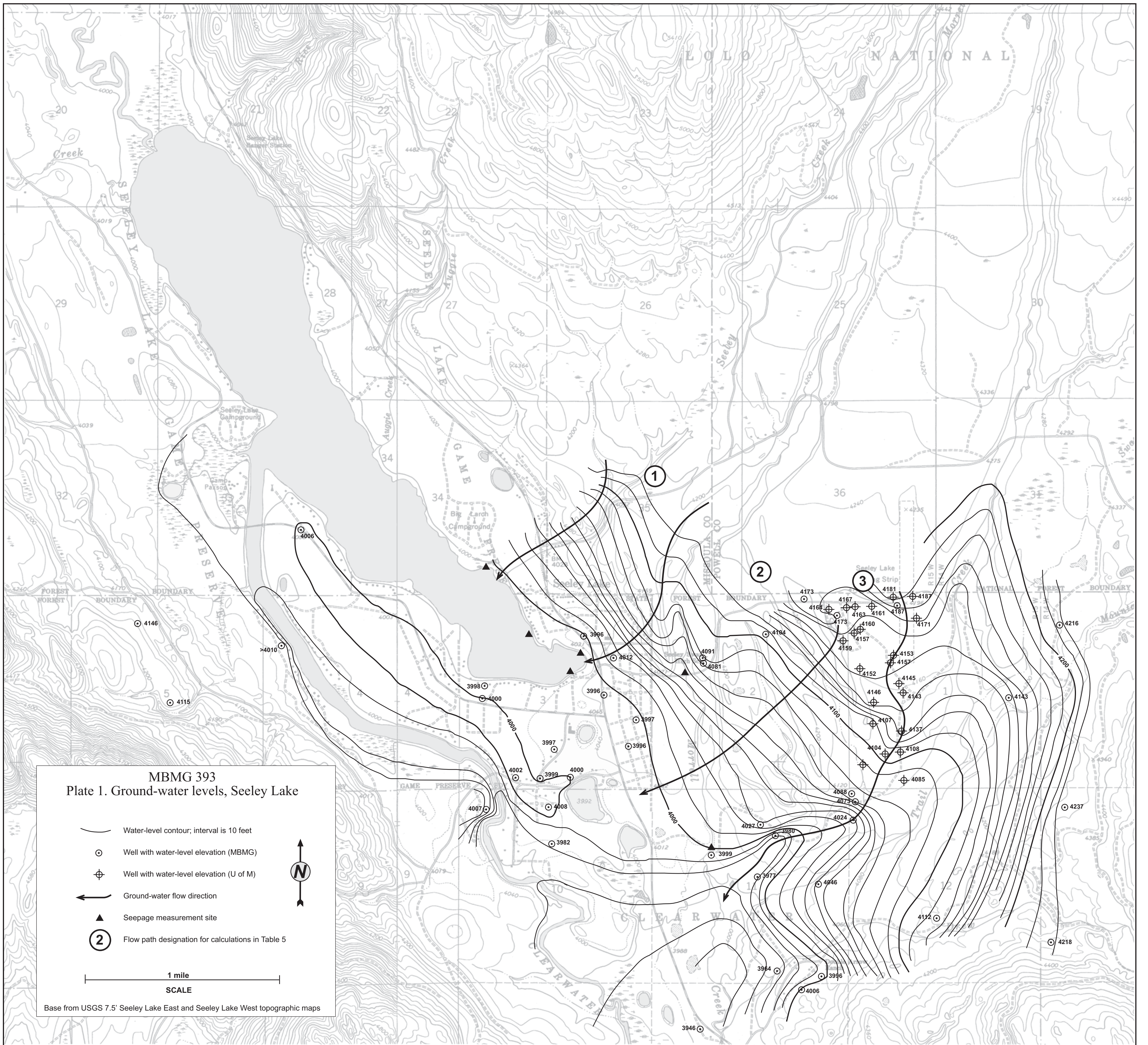

Location	Date installed	Replace?	Size of tank (gal)	Material made of	Depth to top of tank (ft)	Length of drain field (ft)	Width of trench (ft)	Depth of Drain Field (ft)	Elevation (ft)	Purpose of tank	No. households/businesses served	No. people served	Distance from nearest well (ft)	Remarks
16N 15W 14 DACCC	1976	Y	1000	Concrete	0.5	169' Linear PVC			3959	Household	1	2 Bedrooms	100 to D.F.	50' to Tank
16N 15W 14 DCAAA	1989		1000	Concrete	0.5	2-75' Laterals	18	18	3952	Household	1	2 Bedrooms	100	5.5' to Surface Water
16N 15W 14 DBBDC	1989	Y	1000	Concrete		2-70' Laterals	18	18	3952	Household	1	2 Bedrooms	100	3" to Surface Water
16N 15W 14 DDDC	1985	Y	1000	Concrete	1	150' Linear PVC	18-24	18-24	3950	Household	1	2 Bedrooms		
17N 15W 28 ABABC	1993		1000			170' Linear			4000	Household	1	2 Bedrooms		
17N 15W 28 ADC	1995	Y	2-1000	Concrete	1	375 lin-4 laterals	24-36	24-36	3998	Commercial	3 Cabins	21 Bed Spaces		
17N 15W 28 ADC	1996	Y	1000	Concrete	2	Absorption Bed			3998	Commercial	3 Cabins			
17N 15W 28 CBACC	1986		1000	Concrete	1.5	3-50' Laterals	24	24	4021	Household	1	2 Bedrooms	140 lake	
17N 15W 28 CBBAA	1986	Y	1000	Concrete	1	3-50' Laterals	24-36	4021	4021	Household	1	2 Bedrooms		
17N 15W 28 CBDDB	1993		1000	Concrete	1	150 lin-2 laterals	24	24	4021	Household	1	2 Bedrooms	100+ lake	
17N 15W 28 DAB	1994	Y	1000	Concrete	0.5	20x40 seep bed			3998	Commercial	Main Lodge	3 Bedrooms		
17N 15W 29 ABD	1980	Y	1000	Concrete	1	2-3 Ring Pits			4040	Household	1	2 Bedrooms		
17N 15W 29 ACAB	1980		1000	Concrete	1	2-75' Laterals	18	18	4030	Household	1	1 Bedroom		
17N 15W 29 ACAB	1980		1000	Concrete	1	200' Linear PVC	18	18	4030	Household	1	1 Bedroom		
17N 15W 29 ACDA	1979		1000	Concrete	2	3-60' Laterals	18-24	4043	4043	Household	1 or 2	2 Bedrooms		
17N 15W 29 BD	1994		1100	Concrete	2	240 lin-5 laterals	18	18	4040	Household	1	3 Bedrooms		400 Gallon Pump Tank
17N 15W 29 CAA?	1977		1000	Concrete	1.5	3-60' lats, PVC	24	24	4038	Household	1	2 Bedrooms		
17N 15W 33 DABC	1994	Y	1000	Concrete	ground	3-50' Laterals		12	4001	Household	1	2 Bedrooms	100+ lake	
17N 15W 33 DACD	1996	Y	1000	Concrete	1.5	3-50' Laterals	30	30	4001	Household	1	2 Bedrooms	100 lake	
17N 15W 33 DADC	1994	Y	1000	Concrete	1.5	150 lin-2 laterals	24	24	4001	Household	1	2 Bedrooms	100+ lake	
17N 15W 33 DBAB	1982	Y	1000	Concrete	0.3	2-50' Laterals	12	12	4001	Household	1	2 Bedrooms	200 lake	Mound System
17N 15W 34 AAC	1979	Y	1000	Concrete	1.5	250 lin-3 laterals	18-24	18-24	4150	Household	1	3 Bedrooms		
17N 15W 34 AAD	1977	Y	1000			6 Ring Pit			4150	Household	1			
17N 15W 34 ACBBA	1989	Y	1000	Concrete	2	4-50' Laterals	24-36	4018	4018	Household	1	3 Bedrooms	100+ lake	
17N 15W 34 ACBBB	1989		1000	Concrete	1	2-75' Laterals	24	24	4016	Household	1	2 Bedrooms		
17N 15W 34 ACBBC	1983		1000			100' Linear			4016	Household	1	1 Bedroom		
17N 15W 34 ACBBB	1977		1000	Concrete	0.5	200' Linear PVC	18	18	4017	Household	1	3 Bedrooms		
17N 15W 34 ACBDC	1994	Y	1000	Concrete	1	3-70' Laterals	24	24	4015	Household	1	3 Bedrooms		
17N 15W 34 ACCBA	1981		1000	Concrete	0.5	2-75' Laterals	18	18	4013	Household	1	2 Bedrooms		
17N 15W 34 ACCBD	1978		1000	Concrete	0.5	150' Linear PVC	18	18	4011	Household	1	1 Bedroom		
17N 15W 34 ACCCB	1977		1000	Concrete	0.5	200' Linear PVC	18	18	4011	Household	1	3 Bedrooms		
17N 15W 34 ACCCD	1978		1000	Concrete	0.5	150' Linear PVC	18	18	4010	Household	1	1 Bedroom		
17N 15W 34 AD	1996	Y	1000	Concrete	2	150 lin-3 laterals	18-24	4079	4079	Household	1	2 Bedrooms		
17N 15W 34 ADBBC	1994	Y	1000	Concrete	1.3	3-50' Linear	24	24	4040	Household	1	2 Bedrooms		
17N 15W 34 ADBCA	1994	Y	1000	Concrete		43x12 seep bed			4041	Household	1	3 Bedrooms		
17N 15W 34 ADBDA	1993		1000	Concrete	1.3	2-80' Laterals	24	24	4040	Household	1	2 Bedrooms		
17N 15W 34 ADCAA	1992	Y				6 Ring Pit	36	36	4039	Household	1	3 Bedrooms	12+ S.W.	
17N 15W 34 CCCCCA	1984	Y	500	Metal	1.5	2-75' Laterals	18-24	18-24	3999	Household	1	2 Bedrooms		
17N 15W 34 CCCCCB	1984	Y	1000	Concrete		2-75' Laterals			3999	Household	1	2 Bedrooms		
17N 15W 34 DAACA	1985	Y							4020					
17N 15W 34 DAADB	1985	Y	1000						4019	HH & Com.	house, beauty sal			Permit missing in Files. tank added with 2 pumps from salon to existing system

Seeley Lake septic tanks

Location	Date installed	Replace?	Size of tank (gal)	Material made of	Depth to top of tank (ft)	Length of drain field (ft)	Width of trench (ft)	Depth of Drain Field (ft)	Elevation (ft)	Purpose of tank	No. households/businesses served	No. people served	Distance from nearest well (ft)	Remarks
17N 15W 34 DAADCB	1987	Y	1000	Concrete	0.7	3-60' Laterals		18	4018	Commercial				
17N 15W 34 DAADCC	1985	Y	1000	Concrete	1	3-70' Laterals		24	4022	Household	1	3 Bedrooms		
17N 15W 34 DAADD	1984	Y				add 150' to existing			4019	Commercial	1 Day Care			
17N 15W 34 DAB	1987	Y	1000	Concrete	0.7	3-60' Laterals		36	4017	Household	1	3 Bedrooms		
17N 15W 34 DADA	1987	Y	1000	Concrete		3 ring seep pit			4025	Commercial	propane off			
17N 15W 34 DADDD	1988	Y	1000	Concrete	1	3-50' Laterals		24	4027	Household	1	2 Bedrooms		



MBMG 393
Plate 1. Ground-water levels, Seeley Lake

-  Water-level contour; interval is 10 feet
-  Well with water-level elevation (MBMG)
-  Well with water-level elevation (U of M)
-  Ground-water flow direction
-  Seepage measurement site

2 Flow path designation for calculations in Table 5

1 mile
SCALE

Base from USGS 7.5' Seeley Lake East and Seeley Lake West topographic maps

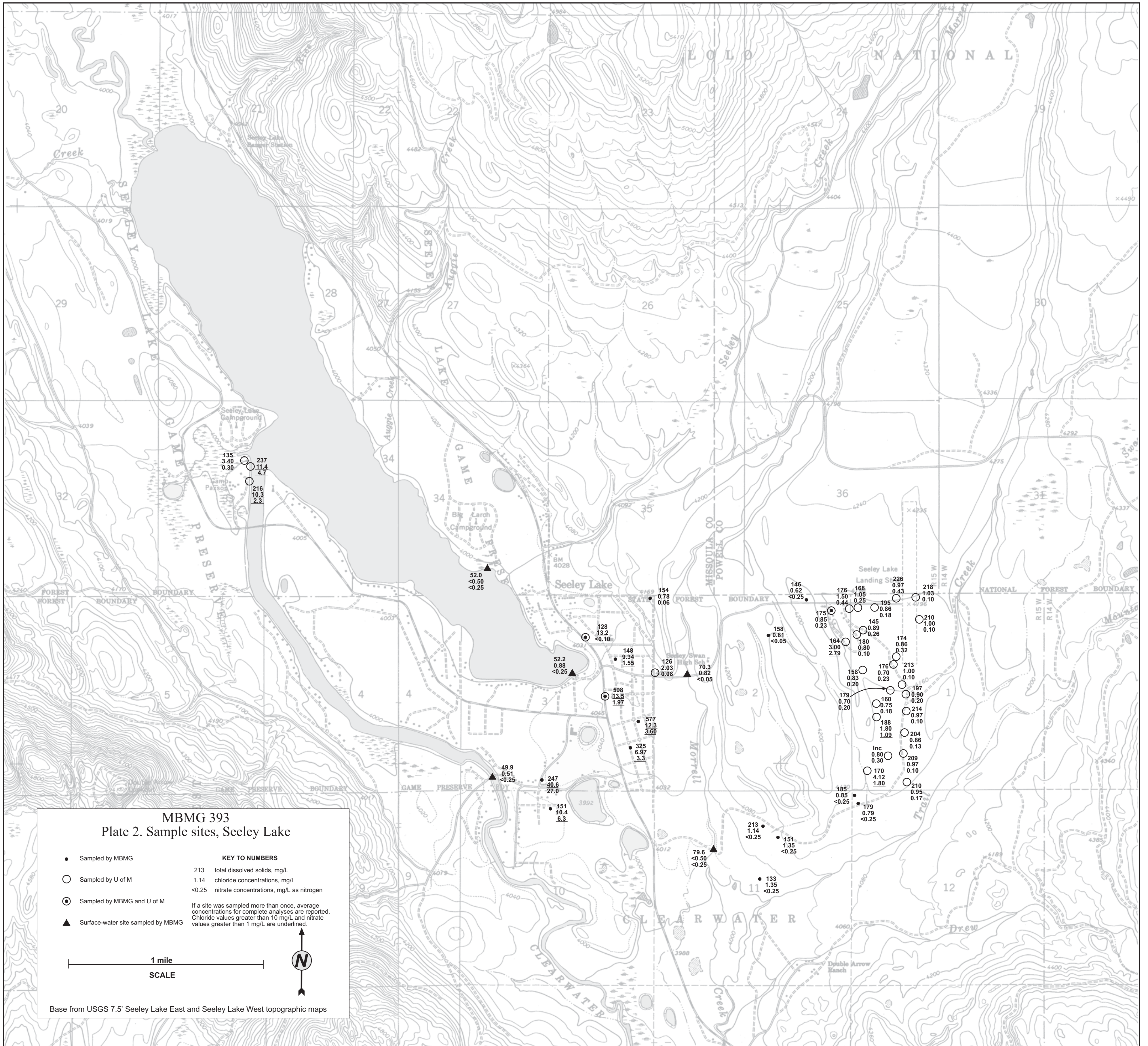

MBMG 393
Plate 2. Sample sites, Seeley Lake

- Sampled by MBMG
- Sampled by U of M
- ⊙ Sampled by MBMG and U of M
- ▲ Surface-water site sampled by MBMG

KEY TO NUMBERS

213	total dissolved solids, mg/L
1.14	chloride concentrations, mg/L
<0.25	nitrate concentrations, mg/L as nitrogen

If a site was sampled more than once, average concentrations for complete analyses are reported. Chloride values greater than 10 mg/L and nitrate values greater than 1 mg/L are underlined.

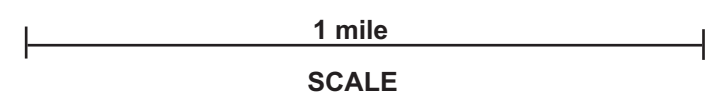

Base from USGS 7.5' Seeley Lake East and Seeley Lake West topographic maps

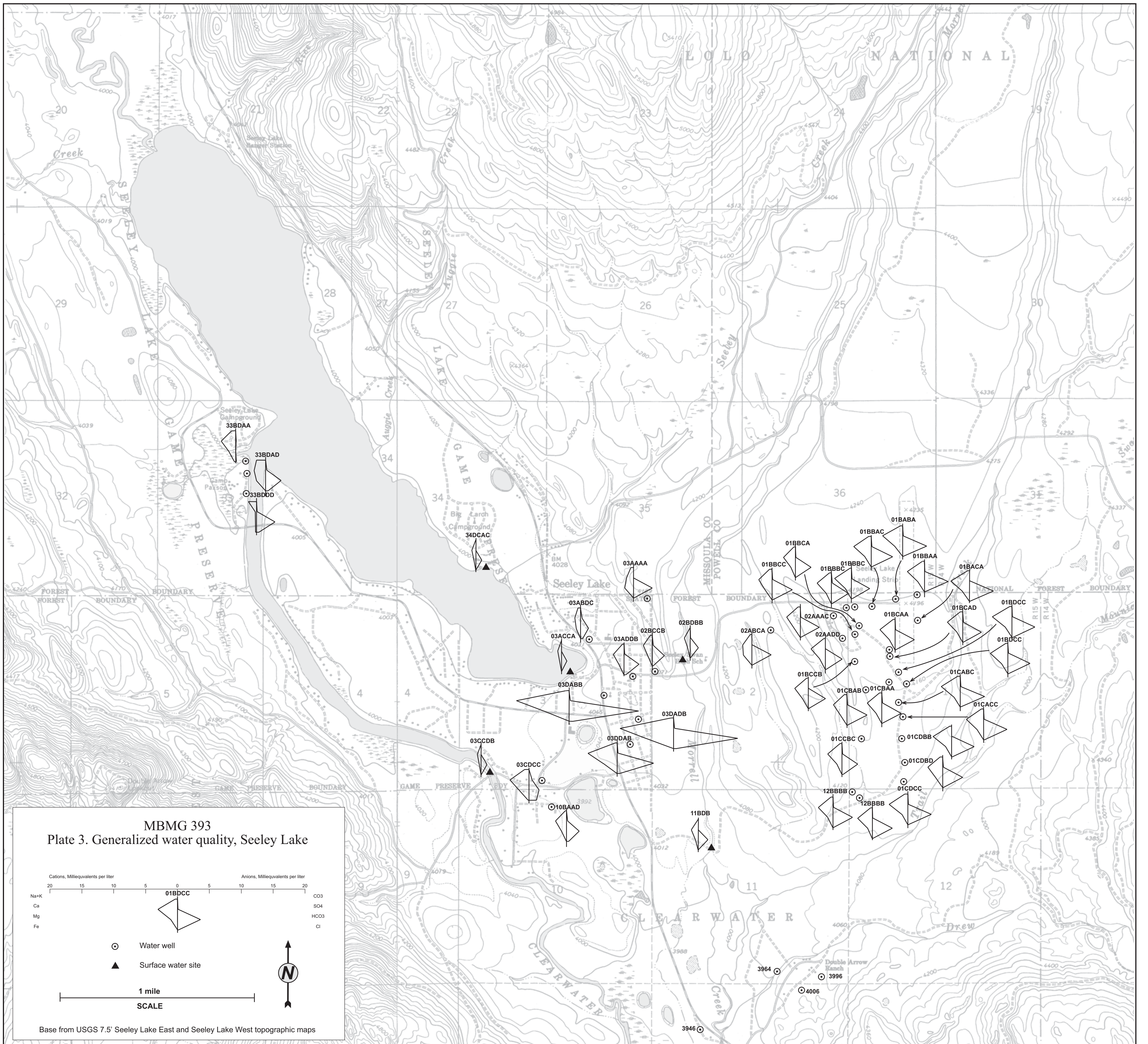

MBMG 393
Plate 3. Generalized water quality, Seeley Lake

Cations, Milliequivalents per liter		Anions, Milliequivalents per liter	
20	15	10	5
0	5	0	5
Na+K			CO3
Ca			SO4
Mg			HCO3
Fe			Cl

○ Water well
 ▲ Surface water site

1 mile
 SCALE

Base from USGS 7.5' Seeley Lake East and Seeley Lake West topographic maps

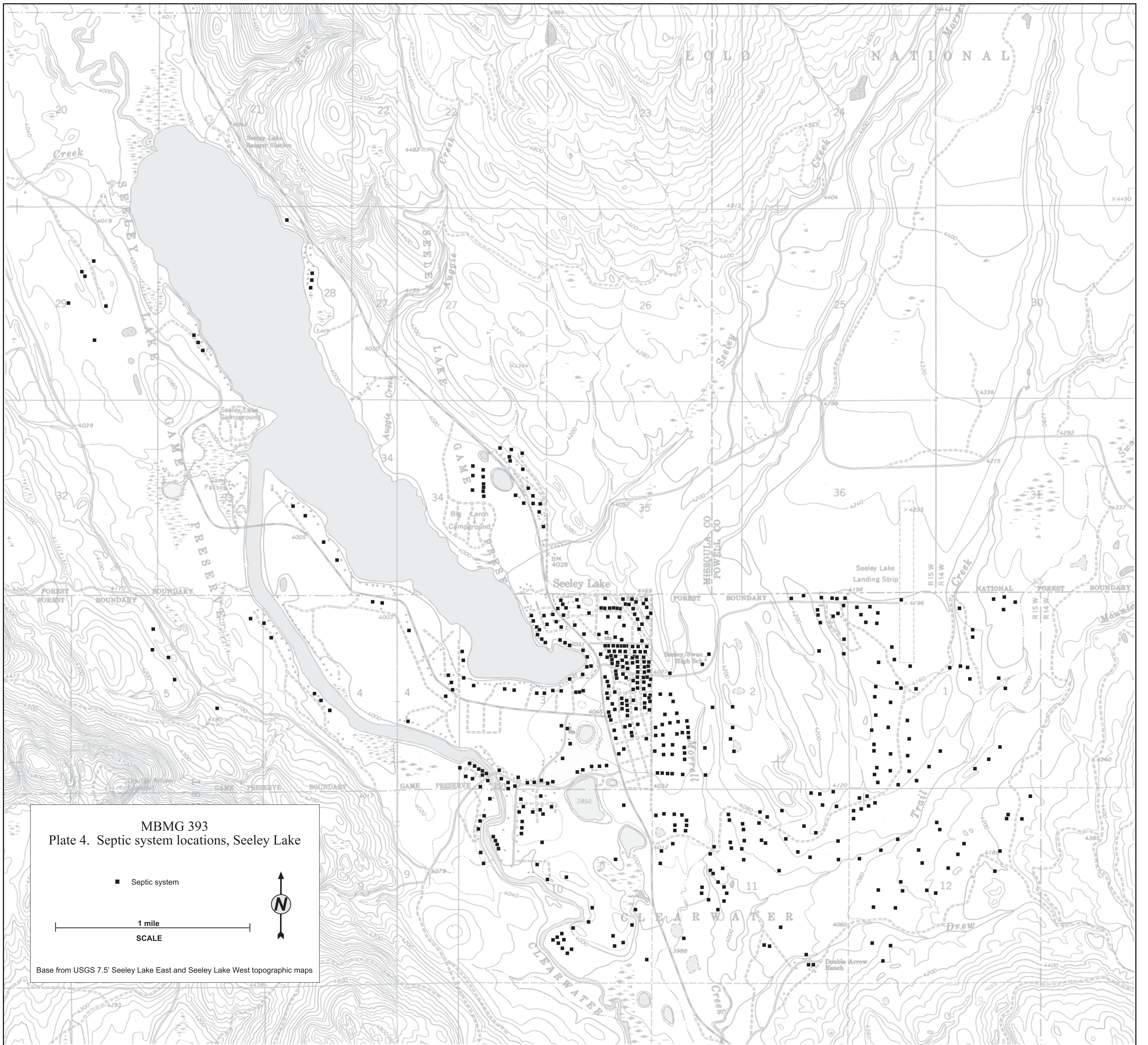

MBMG 393
Plate 4. Septic system locations, Seeley Lake

■ Septic system



1 mile
SCALE

Base from USGS 7.5' Seeley Lake East and Seeley Lake West topographic maps